

SCHÜTTTS[®]
INDUSTRIAL

PRODUCT CATALOGUE

MORE THAN OPENS AND SCHUTTS



CRANE[™]
"Lift with Confidence"

GRANGE[™]
"Move with Confidence"

PROTEX[®]

SCHÜTTTS[™]
HARDWARE

SCHÜTTTS CARGO[™]

SCHÜTTTS STRUTS[™]

WWW.SCHUTTS.COM.AU



OUR VISION

As we now embark on a new growth plan with the amalgamation of three businesses now merging into one large style company, with this we will quickly become one of the leading suppliers into the Industrial / Hardware OEM/ Rural market places by offering the best value for money quality products in our space. We can achieve this with the help of our key suppliers who are without doubt some of the world's best manufacturers in their categories.

You can be assured that throughout this catalogue our products not only meet but exceed the standards of all our customers.

QUALITY PRODUCT

For over 30 years our business has been focused on development and sourcing the highest quality range of products to supply the Australian & New Zealand Market in the lifting, rigging, load restraint OEM Industries. We now embrace this into the other parts of our business, with our new product range that suits a wide variety of industries whilst ensuring that all of our products have been manufactured to meet and exceed the strict standards required for each market.

SERVICE AND KNOWLEDGE

We Supply our products through leading industries in the Industrial, Automotive, Bearings and Fasteners, along with our distributors ensuring suitable product placement to all of our customers with optimal performance per our manufacturer's guidelines.

MORE THAN OPENS AND SCHUTTS

SCHÜTTTS[®]

INDUSTRIAL

CRANE
"Lift with Confidence"



LIFTING EQUIPMENT

GRANGE
"Move with Confidence"



LOAD RESTRAINT

SCHÜTTTS CARGO



UTES, TRUCKS, TRAILER

SCHÜTTTS
HARDWARE



HARDWARE

SCHÜTTTS STRUTS



GAS STRUT

PROTEX[®]



PROTEX FASTENER

MORE THAN OPENS AND SCHÜTTTS

CONTENTS



CRANE Lifting & Rigging

P.01-34

G80 & G100 Chain
Chain Slings
Lifting Components
Lifting Shackles
Eye Nuts & Eye Bolts
Flat & Round Slings
Hoisting Equipment
Material Handling



GRANGE Load Restraint

P.35-42

Ratchet Tie Downs
Ratchets & Straps
Load Restraints
Chains



PROTEX Fasteners

P.43-56

Light Duty
Medium Duty
Heavy Duty
Catchbolts
Bandclamps



SCHUTTS CARGO Utes, Trailers, & Trucks

P.57-70

Bungee Cords & Ropes
Cargo Nets
Ratchet Tie Downs
UTES, Trucks, Trailers
Locks



SCHUTTS HARDWARE Hardware

P.71-94

Turnbuckles
Bow & Dee Shackles
Snap Hooks, Quick Links, Swivels
Handles
Handles & Locks
Rubbers
Hinges
Drawerslides



SCHUTTS STRUTS Struts

P.95-105

6/15 Gas Struts
8/19 Gas Struts
10/22 Gas Struts
14/28 Gas Struts
Stainless Gas Struts



CRANE

“Lift with Confidence”

Covers all of our Lifting & Rigging range of products, which all meet or exceed the tough Australian & New Zealand Standards including Bow & Dee Shackles, Flat & Round Slings, Chain & Lever Blocks, Grade 80 Chain Slings, and a comprehensive range of Grade 80 Lifting Components, Grade 80 Chain from 6mm-13mm, as well as a range of Grade 100 Chain & Chain slings and G100 Components.

01 G80 & G100 Chain **02**

02 Chain Slings **04**

03 Lifting Components **10**

04 Lifting Shackles **17**

05 Eye Nuts & Eye Bolts **19**

06 Flat & Round Slings **20**

07 Hoisting Equipment **25**

08 Material Handling **31**



GRADE 80 LIFTING CHAIN BUCKET							
CODE	CHAIN SIZE	W.L.L	INSIDE LINK		OUTSIDE LINK		QTY IN 50KG BUCKET
			LENGTH	WIDTH	LENGTH	WIDTH	
CLC6B	6mm	1200kg	17.7mm	8.2mm	30.3mm	20.3mm	63m
CLC8B	8mm	2000kg	24mm	11.5mm	39.5mm	26.8mm	36m
CLC10B	10mm	3200kg	30mm	14.2mm	44.7mm	33.3mm	23m

GRADE 80 LIFTING CHAIN DRUM							
CODE	CHAIN SIZE	W.L.L	INSIDE LINK		OUTSIDE LINK		QTY IN 500KG DRUM
			LENGTH	WIDTH	LENGTH	WIDTH	
CLC13D	13mm	5400kg	39.1mm	18.8mm	64.5mm	43.2mm	140m
CLC16D	16mm	8200kg	48.3mm	22.8mm	79mm	53.5mm	90m



GRADE 100 ALLOY STEEL LIFTING CHAIN BUCKET							
CODE	CHAIN SIZE	W.L.L	INSIDE LINK		OUTSIDE LINK		QTY IN BUCKET
			LENGTH	WIDTH	LENGTH	WIDTH	
G1CHN10	10mm	4000kg	30mm	15mm	55mm	35mm	23m
G1CHN13	13mm	6700kg	39mm	20mm	72mm	46mm	13.5m
G1CHN16	16mm	10000kg	48mm	24mm	88mm	56mm	8m

- Conforms to AS 2321 but with 25% higher work load limit.
- Used for lifting purposes.

GRADE 100 ALLOY STEEL LIFTING CHAIN DRUM							
CODE	CHAIN SIZE	W.L.L	INSIDE LINK		OUTSIDE LINK		QTY IN DRUM
			LENGTH	WIDTH	LENGTH	WIDTH	
G1CHN10D	10mm	4000kg	30mm	15mm	55mm	35mm	230m
G1CHN13D	13mm	6700kg	39mm	20mm	72mm	46mm	135m
G1CHN16D	16mm	10000kg	48mm	24mm	88mm	56mm	80m

- Conforms to AS 2321 but with 25% higher work load limit.
- Used for lifting purposes.

CRANE

“Lift with Confidence”



SCHÜTT'S
INDUSTRIAL



G80 SINGLE LEG CHAIN SLINGS



SUPPLIED WITH TEST CERTIFICATE



FITTED WITH A WORKING LOAD LIMIT TAG



SUPPLIED IN A STORAGE PAIL

CRANE
"Lift with Confidence"

GRADE 80 SINGLE LEG CHAIN SLINGS WITH SHORTENING GRAB HOOK & SELF LOCKING HOOK

Code	Chain Size	Effective Length	W.L.L
CS6MM1L1.0M	6mm	1.0mtr	1100kg
CS6MM1L2.0M	6mm	2.0mtr	1100kg
CS8MM1L1.0M	8mm	1.0mtr	2000kg
CS8MM1L2.0M	8mm	2.0mtr	2000kg
CS8MM1L3.0M	8mm	3.0mtr	2000kg
CS8MM1L4.0M	8mm	4.0mtr	2000kg



G80 TWO LEG CHAIN SLINGS



SUPPLIED WITH TEST CERTIFICATE



FITTED WITH A WORKING LOAD LIMIT TAG



SUPPLIED IN A STORAGE PAIL

CRANE
"Lift with Confidence"

GRADE 80 TWO LEG CHAIN SLINGS WITH SHORTENING GRAB HOOKS & SELF LOCKING HOOKS

Code	Chain Size	Effective Length	W.L.L
CS6MM2L1.0M	6mm	1.0mtr	1900kg @ 60°
CS6MM2L2.0M	6mm	2.0mtr	1900kg @ 60°
CS8MM2L2.0M	8mm	2.0mtr	3500kg @ 60°
CS8MM2L3.0M	8mm	3.0mtr	3500kg @ 60°
CS8MM2L4.0M	8mm	4.0mtr	3500kg @ 60°
CS10MM2L2.0M	10mm	2.0mtr	5500kg @ 60°
CS10MM2L3.0M	10mm	3.0mtr	5500kg @ 60°
CS10MM2L4.0M	10mm	4.0mtr	5500kg @ 60°
CS13MM2L2.0M	13mm	2.0mtr	9200kg @ 60°
CS13MM2L3.0M	13mm	3.0mtr	9200kg @ 60°
CS13MM2L4.0M	13mm	4.0mtr	9200kg @ 60°



CHAIN SLINGS

CRANE





G80 FOUR LEG CHAIN SLINGS



SUPPLIED WITH TEST CERTIFICATE



FITTED WITH A WORKING LOAD LIMIT TAG



SUPPLIED IN A STORAGE PAIL

CRANE
"Lift with Confidence"

GRADE 80 FOUR LEG CHAIN SLINGS WITH SHORTENING GRAB HOOKS & SELF LOCKING HOOKS

Code	Chain Size	Effective Length	W.L.L
CS6MM4L2.0M	6mm	2.0mtr	1900kg @ 60°
CS6MM4L3.0M	6mm	3.0mtr	1900kg @ 60°
CS8MM4L2.0M	8mm	2.0mtr	3500kg @ 60°
CS8MM4L3.0M	8mm	3.0mtr	3500kg @ 60°
CS8MM4L4.0M	8mm	4.0mtr	3500kg @ 60°
CS10MM4L2.0M	10mm	2.0mtr	5500kg @ 60°
CS10MM4L3.0M	10mm	3.0mtr	5500kg @ 60°
CS10MM4L4.0M	10mm	4.0mtr	5500kg @ 60°
CS13MM4L2.0M	13mm	2.0mtr	9200kg @ 60°
CS13MM4L3.0M	13mm	3.0mtr	9200kg @ 60°
CS13MM4L4.0M	13mm	4.0mtr	9200kg @ 60°



LIFTING FOR SAFETY

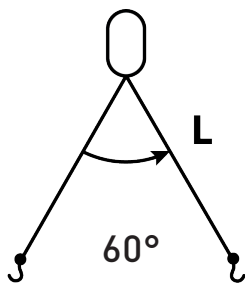

PREFERRED METHOD

Base = Length (L, Length of Leg)

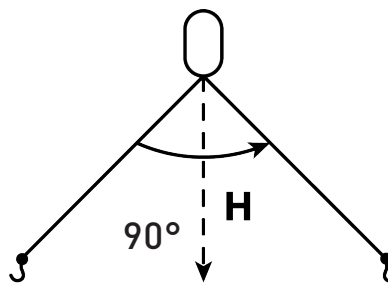

MAXIMUM RECOMMENDED

0.5 x Base = Height (H)

Do not use slings at angle greater than 120° as the horizontal forces place too much load on the sling legs

Note: Maximum 60° angle for reeved and basket sling.

CHAIN SLINGS

CRANE

ALLOY GRADE (T80) CHAIN SLINGS To AS 3775.1-2014 WORKING LOAD LIMIT CHART

CHAIN DIA	SINGLE LEG SLINGS			SLINGS OF 2, 3 OR 4 LEGS			ENDLESS SLINGS		
Chain Size	Straight lift	Shortened Straight lift	Reeved Sling	Slings of 2, 3 or 4 legs		Basket Sling		Reeved Sling	
				60°	90°	60° (max)	60°		90°
6mm	1.1 Tonne	1.1 Tonne	0.8 Tonne	1.9T	1.6T	1.5 Tonne	1.5T	1.2T	1.7 Tonne
7mm	1.5 Tonne	1.5 Tonne	1.1 Tonne	2.6T	2.1T	2.0 Tonne	2.0T	1.6T	2.3 Tonne
8mm	2.0 Tonne	2.0 Tonne	1.5 Tonne	3.5T	2.8T	2.6 Tonne	2.6T	2.1T	3.0 Tonne
10mm	3.2 Tonne	3.2 Tonne	2.4 Tonne	5.5T	4.5T	4.1 Tonne	4.1T	3.4T	4.8 Tonne
13mm	5.3 Tonne	5.3 Tonne	4.0 Tonne	9.2T	7.5T	6.9 Tonne	6.9T	5.6T	8.0 Tonne
16mm	8.0 Tonne	8.0 Tonne	6.0 Tonne	13.8T	11.3T	10.4 Tonne	14.5T	11.9T	5.6 Tonne
19mm	11.2 Tonne	11.2 Tonne	8.4 Tonne	19.2T	15.8T	14.5 Tonne	14.5T	11.9T	5.6 Tonne
20mm	12.5 Tonne	12.5 Tonne	9.4 Tonne	21.6T	17.6T	16.3 Tonne	16.3T	13.3T	18.8 Tonne
22mm	15.0 Tonne	15.0 Tonne	11.3 Tonne	26.0T	21.2T	19.5 Tonne	19.5T	15.9T	22.5 Tonne
26mm	21.2 Tonne	21.2 Tonne	15.9 Tonne	36.7T	29.9T	27.6 Tonne	27.6T	22.5T	31.8 Tonne
32mm	31.5 Tonne	31.5 Tonne	23.6 Tonne	54.5T	44.4T	41.0 Tonne	41.0T	33.4T	47.3 Tonne



G100 TWO LEG CHAIN SLINGS

- SUPPLIED WITH TEST CERTIFICATE**
- FITTED WITH A WORKING LOAD LIMIT TAG**
- SUPPLIED IN A STORAGE PAIL**
- "Lift with Confidence"**

GRADE 100 TWO LEG CHAIN SLINGS WITH SHORTENING GRAB HOOKS & SELF LOCKING HOOKS

Code	Chain Size	Effective Length	W.L.L
G1CS10MM2L2.0M	10mm	2.0mtr	6900kg @ 60°
G1CS10MM2L4.0M	10mm	4.0mtr	6900kg @ 60°
G1CS13MM2L2.0M	13mm	2.0mtr	11600kg @ 60°
G1CS13MM2L3.0M	13mm	3.0mtr	11600kg @ 60°
G1CS13MM2L4.0M	13mm	4.0mtr	11600kg @ 60°

ALLOY GRADE (T100) CHAIN SLINGS To AS 3775.1-2014

LIFTING FOR SAFETY

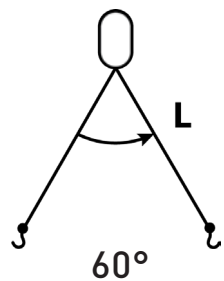

PREFERRED METHOD
Base = Length (L, Length of Leg)

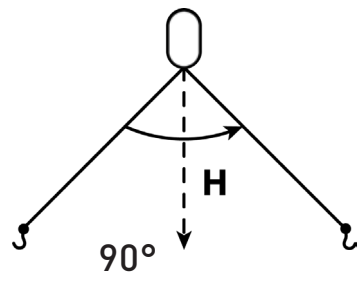

MAXIMUM RECOMMENDED
0.5 x Base = Height (H)

Do not use slings at angle greater than 120° as the horizontal forces place too much load on the sling legs
Note: Maximum 60° angle for reeved and basket sling.

G100 FOUR LEG CHAIN SLINGS

✓ SUPPLIED WITH TEST CERTIFICATE

✓ FITTED WITH A WORKING LOAD LIMIT TAG

✓ SUPPLIED IN A STORAGE PAIL

CRANE
"Lift with Confidence"



GRADE 100 FOUR LEG CHAIN SLINGS WITH SHORTENING GRAB HOOKS & SELF LOCKING HOOKS

Code	Chain Size	Effective Length	W.L.L
G1CS10MM4L2.0M	10mm	2.0mtr	6900kg @ 60°
G1CS10MM4L3.0M	10mm	3.0mtr	6900kg @ 60°
G1CS10MM4L4.0M	10mm	4.0mtr	6900kg @ 60°
G1CS13MM4L2.0M	13mm	2.0mtr	11600kg @ 60°
G1CS13MM4L3.0M	13mm	3.0mtr	11600kg @ 60°
G1CS13MM4L4.0M	13mm	4.0mtr	11600kg @ 60°

ALLOY GRADE (T100) CHAIN SLINGS To AS 3775.1-2014 WORKING LOAD LIMIT CHART

CHAIN DIA	SLINGS OF 2, 3 OR 4 LEGS			ENDLESS SLINGS		
	Straight Sling		Reeved Sling	Basket Sling		Reeved Sling
Chain Size	60°	90°	60° (max)	60° Tonne	90°	
10mm	6.9 Tonne	5.6 Tonne	5.2 Tonne	5.2 Tonne	4.2 Tonne	6 Tonne
13mm	11.6 Tonne	9.5 Tonne	8.7 Tonne	8.7 Tonne	7.1 Tonne	10 Tonne
16mm	17.3 Tonne	14.1 Tonne	13.0 Tonne	13.0 Tonne	10.6 Tonne	15 Tonne
20mm	27.7 Tonne	22.5 Tonne	20.8 Tonne	20.8 Tonne	17 Tonne	24 Tonne

NOTE: The quoted W.L.L is approximate and relevant to Grange Lift products.

GRADE 80 LIFTING COMPONENTS

LIFTING COMPONENTS
CRANE

- ✓ MADE FROM G80 STEEL
- ✓ MARKED WITH CHAIN SIZE GRADE AND MANUFACTURERS CODE

✓ TEST CERTIFICATES AVAILABLE UPON REQUEST



GRADE 80 ALLOY STEEL SINGLE/DOUBLE OBLONG LINKS				
CODE	DESCRIPTION	SINGLE	DOUBLE	W.L.L
25821	S/D oblong link (inside 110x55mm) (D = 10mm)	7mm	6mm	1.6 T
25824	S/D oblong link (inside 120x60mm) (D = 12mm)	8mm	7mm	2.7 T
25823	S/D oblong link (inside 140x75mm) (D = 15mm)	10mm	8mm	3.5 T
25826	S/D oblong link (inside 160x90mm) (D = 20mm)	13mm	10mm	5.5 T
25831	S/D oblong link (inside 190x105mm) (D = 25mm)	16mm	13mm	9.4T



GRADE 80 ALLOY STEEL MULTI MASTER OBLONG LINKS			
CODE	DESCRIPTION	SIZE	W.L.L
25751A	Multi master oblong link (inside 120x60mm)	6/7mm	3.15 T
25752	Multi master oblong link (inside 150x85mm)	7/8mm	4.25 T
25753	Multi master oblong link (inside 180x95mm)	10mm	6.7 T
25754	Multi master oblong link (inside 190x105mm)	13mm	11.2 T
25755	Multi master oblong link (inside 190x105mm)	16mm	17T



GRADE 80 ALLOY STEEL HAMMER TYPE CONNECTING LINKS		
CODE	DESCRIPTION	W.L.L
25201	6mm Connecting link (hammer assembly)	1.1 T
25203	7/8mm Connecting link (hammer assembly)	2 T
25204	10mm Connecting link (hammer assembly)	3.2 T
25205	13mm Connecting link (hammer assembly)	5.3 T
25206	16mm Connecting link (hammer assembly)	8T
25207	20mm Connecting link (hammer assembly)	12T



GRADE 80 ALLOY STEEL CLEVIS SHORTENING GRAB HOOK w/WINGS		
CODE	DESCRIPTION	W.L.L
25101	6mm Clevis shortening grab hook with wings	1.1 T
25102	7/8mm Clevis shortening grab hook with wings	2 T
25103	10mm Clevis shortening grab hook with wings	3.2 T
25104	13mm Clevis shortening grab hook with wings	5.3 T



GRADE 80 ALLOY STEEL CLEVIS SHORTENING CLUTCHES		
CODE	DESCRIPTION	W.L.L
25181	6mm Clevis shortening clutch	1.1T
25182	7/8mm Clevis shortening clutch	2 T
25183	10mm Clevis shortening clutch	3.2 T
25184	13mm Clevis shortening clutch	5.3 T



GRADE 80 ALLOY STEEL CLEVIS SELF LOCKING HOOKS		
CODE	DESCRIPTION	W.L.L
25021	6mm Clevis self locking hook	1.1 T
25022	7/8mm Clevis self locking hook	2 T
25023	10mm Clevis self locking hook	3.2 T
25024	13mm Clevis self locking hook	5.3 T



GRADE 80 ALLOY STEEL CLEVIS SLING HOOK w/SAFETY LATCH		
CODE	DESCRIPTION	W.L.L
25371	6mm Clevis sling hook with safety latch	1.1 T
25372	7/8mm Clevis sling hook with safety latch	2 T
25373	10mm Clevis sling hook with safety latch	3.2 T
25374	13mm Clevis sling hook with safety latch	5.3 T



GRADE 80 ALLOY STEEL EYE TYPE SHORTENING GRAB HOOK w/WINGS		
CODE	DESCRIPTION	W.L.L
25081	6mm Eye type shortening grab hook with wings	1.1 T
25082	7/8mm Eye type shortening grab hook with wings	2 T
25083	10mm Eye type shortening grab hook with wings	3.2 T
25084	13mm Eye type shortening grab hook with wings	5.3 T



GRADE 80 ALLOY STEEL EYE TYPE SLING HOOK w/SAFETY LATCH		
CODE	DESCRIPTION	W.L.L
25165	6mm Eye type sling hook with safety latch	1.1 T
25166	7/8mm Eye type sling hook with safety latch	2 T
25167	10mm Eye type sling hook with safety latch	3.2 T
25168	13mm Eye type sling hook with safety latch	5.3 T



GRADE 80 ALLOY STEEL EYE SWIVEL SLING HOOK w/SAFETY LATCH		
CODE	DESCRIPTION	W.L.L
25091	6mm Eye swivel sling hook with safety latch	1.1T
25092	7/8mm Eye swivel sling hook with safety latch	2 T
25093	10mm Eye swivel sling hook with safety latch	3.2 T
25094	13mm Eye swivel sling hook with safety latch	5.3 T



GRADE 80 ALLOY STEEL EYE TYPE SWIVEL SELF LOCKING HOOKS		
CODE	DESCRIPTION	W.L.L
25041	6mm Eye type swivel self locking hook	1.1 T
25042	7/8mm Eye type swivel self locking hook	2 T
25043	10mm Eye type swivel self locking hook	3.2 T
25044	13mm Eye type swivel self locking hook	5.3 T



GRADE 80 ALLOY STEEL EYE TYPE SWIVEL SELF LOCKING HOOKS w/BEARING

CODE	DESCRIPTION	W.L.L
25047B	6mm Eye type swivel self locking hook with bearing	1.1 T
25048B	7/8mm Eye type swivel self locking hook with bearing	2 T
25049B	10mm Eye type swivel self locking hook with bearing	3.2 T
25050B	13mm Eye type swivel self locking hook with bearing	5.3 T



GRADE 80 ALLOY STEEL EYE TYPE SELF LOCKING HOOKS

CODE	DESCRIPTION	W.L.L
25001	6mm Eye type self locking hook	1.1 T
25002	7/8mm Eye type self locking hook	2 T
25003	10mm Eye type self locking hook	3.2 T
25004	13mm Eye type self locking hook	5.3 T



GRADE 80 ALLOY STEEL CONTAINER & FOUNDRY HOOKS

CODE	DESCRIPTION	W.L.L
CCHL	Container hook left	12.5T
CCHR	Container hook right	12.5T
CFH3T	3T Foundry hook	3T
CFH8T	8T Foundry hook	8T



GRADE 80 BOLT ON G80 LUG LINK

CODE	DESCRIPTION	WEIGHT	W.L.L
254211	Bolt on Grade 80 lug link	0.575kg	1.12 T
254213	Bolt on Grade 80 lug link	1.02kg	3.15 T
254215	Bolt on Grade 80 lug link	2.00kg	5.3 T



GRADE 80 ALLOY STEEL WELD ON LIFTING LUG			
CODE	DESCRIPTION	WEIGHT	W.L.L
CWOL1	1 Tonne Weld on Lifting Lug	0.4kg	1.12 T
CWOL2	2 Tonne Weld on Lifting Lug	0.47kg	2 T
CWOL3	3 Tonne Weld on Lifting Lug	0.69kg	3.15 T
CWOL5	5 Tonne Weld on Lifting Lug	1.46kg	5.3 T
CWOL8	8 Tonne Weld on Lifting Lug	2.5kg	8T



GRADE 80 ALLOY STEEL WELD ON LIFTING HOOK			
CODE	DESCRIPTION	WEIGHT	W.L.L
CWH2	2 Tonne Weld on Hook	0.45kg	2T
CWH3	3 Tonne Weld on Hook	0.65kg	3.15T
CWH5	5 Tonne Weld on Hook	1.35kg	5.2T
CWH8	8 Tonne Weld on Hook	2.35kg	8T



GRADE 80 ALLOY STEEL SWIVEL LIFTING POINT			
CODE	DESCRIPTION	WEIGHT	W.L.L
CLPM8	Swivel Lifting point M8x10.4	0.36kg	0.3 T
CLPM10	Swivel Lifting point M10x15.4	0.38kg	0.63 T
CLPM12	Swivel Lifting point M12x18	0.71kg	1 T
CLPM16	Swivel lifting point M16x24	0.74kg	1.5 T
CLPM20	Swivel Lifting point M20x30	1.19kg	2.5 T



GRADE 80 ALLOY STEEL PANEL CLUTCHES (Swift)		
CODE	DESCRIPTION	W.L.L
25251	1-1.3 Tonne Panel clutch	1-1.3 T
25252	1.5-2.5 Tonne Panel clutch	1.5-2.5 T
25253	3-5 Tonne Panel clutch	3-5 T
25254	6-10 Tonne Panel clutch	6-10 T

GRADE 100 LIFTING COMPONENTS



MADE FROM G100 ALLOY STEEL



TEST CERTIFICATES AVAILABLE UPON REQUEST



MARKED WITH CHAIN SIZE GRADE AND MANUFACTURERS CODE

LIFTING COMPONENTS

CRANE



GRADE 100 ALLOY STEEL SINGLE/DOUBLE OBLONG LINKS

CODE	SIZE	DESCRIPTION	W.L.L
G10ML10	10mm	S/D oblong link (inside 160x95mm)	6.9 T
G10ML13	13mm	S/D oblong link (inside 180x100mm)	11.6 T
G10ML16	16mm	S/D oblong link (inside 240x140mm)	17.3 T

- Conforms to AS 3776 but with 25% higher work load limit.



GRADE 100 ALLOY STEEL MULTI MASTER OBLONG LINKS

CODE	SIZE	DESCRIPTION	W.L.L
G1MML10	10mm	Multi master oblong link (inside 180x100mm)	6.9 T
G1MML13	13mm	Multi master oblong link (inside 230x125mm)	11.6 T
G1MML16	16mm	Multi master oblong link (inside 290x160mm)	17.3 T

- Conforms to AS 3776 but with 25% higher work load limit.



GRADE 100 ALLOY STEEL HAMMER TYPE CONNECTING LINKS

CODE	SIZE	DESCRIPTION	W.L.L
G1CL10	10mm	Connecting link (hammer assembly)	4 T
G1CL13	13mm	Connecting link (hammer assembly)	6.7 T
G1CL16	16mm	Connecting link (hammer assembly)	10 T

- Conforms to AS 3776 but with 25% higher work load limit.



GRADE 100 ALLOY STEEL CLEVIS SHORTENING GRAB HOOK w/WINGS			
CODE	SIZE	DESCRIPTION	W.L.L
G1CGH10	10mm	Clevis shortening grab hook with wings	4 T
G1CGH13	13mm	Clevis shortening grab hook with wings	6.7 T
G1CGH16	16mm	Clevis shortening grab hook with wings	10 T

● Conforms to AS 3776 but with 25% higher work load limit.



GRADE 100 ALLOY STEEL CLEVIS SELF LOCKING HOOKS			
CODE	SIZE	DESCRIPTION	W.L.L
G1CLH10	10mm	Clevis self locking hook	4 T
G1CLH13	13mm	Clevis self locking hook	6.7 T
G1CLH16	16mm	Clevis self locking hook	10 T

● Conforms to AS 3776 but with 25% higher work load limit.

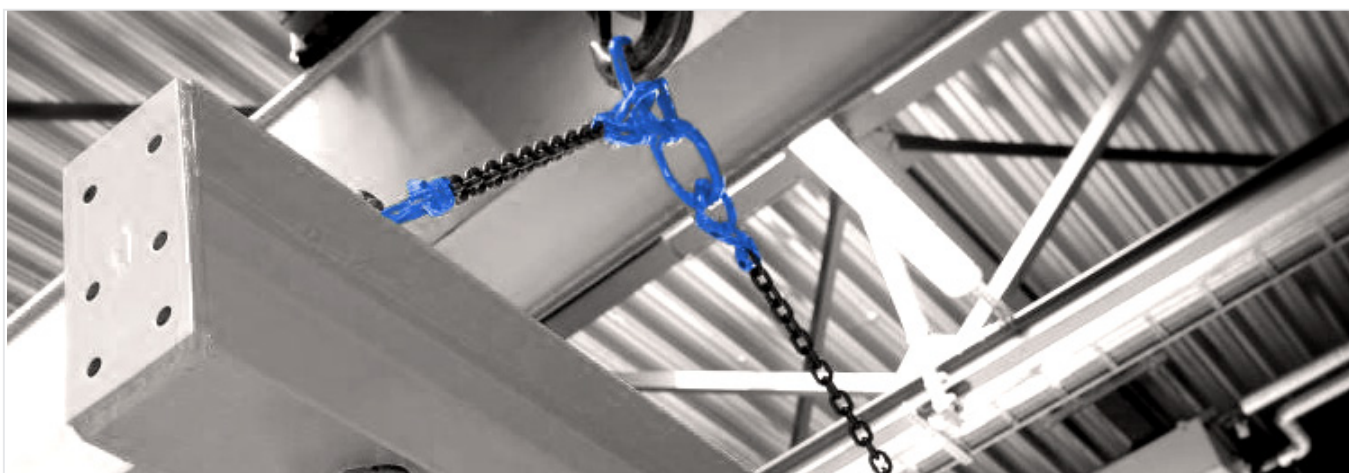

NOTE:

- Do not weld Grade 100 Chain or fittings to another material or try to join them. The heat applied during the welding process would be detrimental to the product and would adversely and significantly compromise its performance.
- Grade 100 Chain and fittings must never be hot dip galvanised, mechanically galvanised or electroplated. The risks of hydrogen embitterment are severe.
- It is important to check lifting chain and its components regularly, based on their frequency of use. Please allow for a quick visual check that the chain is seated in the components correctly.
- Grade 100 Chain and fittings should not be used in acidic or other corrosive environments.

GRADE S ALLOY SHACKLES

- ✓ MARKED WITH WORKING LOAD LIMIT
- ✓ TEST CERTIFICATES AVAILABLE UPON REQUEST

LIFTING SHACKLES

CRANE



GRADE S ALLOY STEEL SCREW PIN BOW SHACKLES			
CODE	DESCRIPTION	SIZE	W.L.L
20921	Screw pin bow shackle	6mm	500kg
20922	Screw pin bow shackle	8mm	750kg
20923	Screw pin bow shackle	10mm	1000kg
20924	Screw pin bow shackle	11mm	1500kg
20925	Screw pin bow shackle	13mm	2000kg
20926	Screw pin bow shackle	16mm	3200kg
20927	Screw pin bow shackle	19mm	4750kg
20928	Screw pin bow shackle	22mm	6500kg
20929	Screw pin bow shackle	25mm	8500kg
20930	Screw pin bow shackle	29mm	9500kg
20931	Screw pin bow shackle	32mm	12000kg
20932	Screw pin bow shackle	35mm	13500kg
20933	Screw pin bow shackle	38mm	17000kg
20934	Screw pin bow shackle	44mm	25000kg
20935	Screw pin bow shackle	51mm	35000kg



GRADE S ALLOY STEEL SCREW PIN DEE SHACKLES			
CODE	DESCRIPTION	SIZE	W.L.L
20901	Screw pin dee shackle	6mm	500kg
20902	Screw pin dee shackle	8mm	750kg
20903	Screw pin dee shackle	10mm	1000kg
20904	Screw pin dee shackle	11mm	1500kg
20905	Screw pin dee shackle	13mm	2000kg
20906	Screw pin dee shackle)	16mm	3200kg
20907	Screw pin dee shackle	19mm	4750kg
20908	Screw pin dee shackle	22mm	6500kg
20909	Screw pin dee shackle	25mm	8500kg
20910	Screw pin dee shackle	29mm	9500kg
20911	Screw pin dee shackle	32mm	12000kg
20912	Screw pin dee shackle	35mm	13500kg
20913	Screw pin dee shackle	38mm	17000kg
20914	Screw pin dee shackle	44mm	25000kg
20915	Screw pin dee shackle	51mm	35000kg



GRADE S ALLOY STEEL SAFETY PIN BOW SHACKLES			
CODE	DESCRIPTION	SIZE	W.L.L
20961	Safety pin bow shackle	13mm	2000kg
20962	Safety pin bow shackle	16mm	3200kg
20963	Safety pin bow shackle	19mm	4750kg
20964	Safety pin bow shackle	22mm	6500kg
20965	Safety pin bow shackle	25mm	8500kg
20966	Safety pin bow shackle	29mm	9500kg



GRADE S ALLOY STEEL SAFETY PIN DEE SHACKLES			
CODE	DESCRIPTION	SIZE	W.L.L
20941	Safety pin dee shackle	13mm	2000kg
20942	Safety pin dee shackle	16mm	3200kg
20943	Safety pin dee shackle	19mm	4750kg
20944	Safety pin dee shackle	22mm	6500kg
20945	Safety pin dee shackle	25mm	8500kg
20946	Safety pin dee shackle	29mm	9500kg

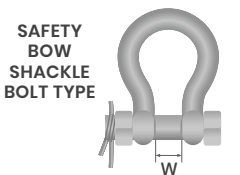
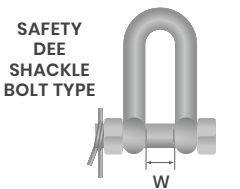
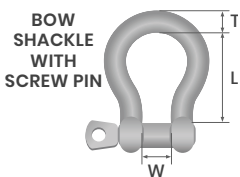
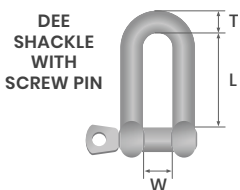

GRADE S ALLOY STEEL SHACKLES										
Dee Shackle Code	Inside Length D Type (L) mm	Inside Width D Type (W) mm	Material Thickness D Type (D) mm	Screw Pin Thickness mm	Bow Shackle Code	Inside Length B Type (L) mm	Inside Width B Type (W) mm	Material Thickness B Type (D) mm	Screw Pin Thickness mm	Working Load Limited Metric Tonne
20901	22.0	12.0	6.0	8.0	20921	29.0	12.0	6.0	8.0	0.5
20902	26.0	13.0	8.0	10.0	20922	31.0	13.0	8.0	10.0	0.75
20903	32.0	17.0	10.0	11.0	20923	37.0	17.0	10.0	11.0	1
20904	37.0	18.0	11.0	13.0	20924	43.0	18.0	11.0	13.0	1.5
20905	41.0	21.0	13.0	16.0	20925	48.0	21.0	13.0	16.0	2
20906	51.0	27.0	16.0	19.0	20926	61.0	27.0	16.0	19.0	3.2
20907	60.0	32.0	19.0	22.0	20927	72.0	32.0	19.0	22.0	4.7
20908	71.0	37.0	22.0	25.0	20928	84.0	37.0	22.0	25.0	6.5
20909	81.0	43.0	25.0	28.0	20929	95.0	43.0	25.0	28.0	8.5
20910	90.0	46.0	29.0	32.0	20930	108.0	46.0	29.0	32.0	9.5
20911	100.0	52.0	32.0	36.0	20931	119.0	52.0	32.0	36.0	12
20912	113.0	57.0	35.0	39.0	20932	133.0	57.0	35.0	39.0	13.5
20913	124.0	60.0	38.0	42.0	20933	146.0	60.0	38.0	42.0	17
20914	146.0	73.0	44.0	56.0	20934	146.0	73.0	44.0	56.0	25
20915	197.0	83.0	51.0	56.0	20935	197.0	83.0	51.0	56.0	35

EYE NUTS & BOLTS

EYE-NUTS & BOLTS

CRANE



ZINC PLATED LIFTING EYEBOLTS DIN 580 STANDARD





CODE	DESCRIPTION	W.L.L
CEB6	6mm Lifting eyebolt	70kg
CEB8	8mm Lifting eyebolt	140kg
CEB10	10mm Lifting eyebolt	230kg
CEB12	12mm Lifting eyebolt	340kg
CEB16	16mm Lifting eyebolt	700kg
CEB20	20mm Lifting eyebolt	1200kg
CEB24	24mm Lifting eyebolt	1800kg
CEB30	30mm Lifting eyebolt	3600kg



ZINC PLATED LIFTING EYENUTS DIN 582 STANDARD

CODE	DESCRIPTION	W.L.L
CEN6	6mm Lifting eye nut	70kg
CEN8	8mm Lifting eye nut	140kg
CEN10	10mm Lifting eye nut	230kg
CEN12	12mm Lifting eye nut	340kg
CEN16	16mm Lifting eye nut	700kg
CEN20	20mm Lifting eye nut	1200kg
CEN24	24mm Lifting eye nut	1800kg
CEN30	30mm Lifting eye nut	3600kg

ZINC PLATED LIFTING EYEBOLTS DIN 580 STANDARD

EYE BOLTS SIZE	SINGLE EYE BOLT		PAIR OF EYE BOLTS		
	Axial 	Side 90° 	30° Angle 	60° Angle 	90° Angle 
M6	0.07	0.018	0.088	0.056	0.035
M8	0.14	0.035	0.176	0.112	0.07
M10	0.23	0.058	0.29	0.184	0.115
M12	0.34	0.085	0.428	0.272	0.17
M16	0.70	0.175	0.882	0.56	0.35
M20	1.20	0.3	1.512	0.96	0.6
M22	1.50	0.375	1.89	1.2	0.75
M24	1.80	0.45	2.268	1.44	0.9
M27	2.50	0.625	3.13	2.0	1.25
M30	3.60	0.9	4.53	2.88	1.80

W.L.L = Working Load Limit

• COLLAR SHALL BE SEATED AGAINST THREADED SURFACE



FLAT SLINGS

Robust and made at the highest quality. Ideal for all heavy lifting.



FULLY CERTIFIED



ROBUST TAGS



SUPER BRIGHT DENSE FABRIC



REINFORCED EYES



**SAFETY
FACTOR
8 TO 1**

W.L.L 1000KG (Violet)	
CODE	LENGTH
FS11	1mtr
FS12	2mtr
FS13	3mtr
FS14	4mtr
FS17	7mtr
FS18	8mtr



W.L.L 5000KG (Red)	
CODE	LENGTH
FS53	3mtr
FS55	5mtr
FS56	6mtr
FS58	8mtr
FS510	10mtr



W.L.L 2000KG (Green)	
CODE	LENGTH
FS21	1mtr
FS22	2mtr
FS23	3mtr
FS24	4mtr
FS25	5mtr
FS26	6mtr
FS28	8mtr

W.L.L 3000KG (Yellow)	
CODE	LENGTH
FS31	1mtr
FS32	2mtr
FS33	3mtr
FS34	4mtr
FS35	5mtr
FS36	6mtr
FS37	7mtr
FS38	8mtr

W.L.L 4000KG (Grey)	
CODE	LENGTH
FS42	2mtr
FS43	3mtr
FS44	4mtr
FS45	5mtr
FS46	6mtr



W.L.L 6000KG (Brown)	
CODE	LENGTH
FS63	3mtr
FS64	4mtr
FS66	6mtr

W.L.L 8000KG (Blue)	
CODE	LENGTH
FS84	4mtr
FS86	6mtr
FS88	8mtr

W.L.L 10000KG (Orange)	
CODE	LENGTH
FS108	8mtr
FS1010	10mtr



W.L.L = Working Load Limit

• COLLAR SHALL BE SEATED AGAINST THREADED SURFACE



ROUND SLINGS

High quality, dense fabric, protects the internal fibres meaning a longer operational life.



FULLY CERTIFIED



ROBUST TAGS



SUPER BRIGHT DENSE FABRIC



**SAFETY
FACTOR
7 TO 1**

W.L.L 1000KG (Violet)	
CODE	LENGTH
RS11	1mtr
RS12	2mtr
RS13	3mtr
RS14	4mtr
RS15	5mtr
RS16	6mtr



W.L.L 5000KG (Red)	
CODE	LENGTH
RS52	2mtr
RS53	3mtr
RS54	4mtr
RS55	5mtr
RS56	6mtr
RS58	8mtr
RS510	10mtr



W.L.L 2000KG (Green)	
CODE	LENGTH
RS21	1mtr
RS22	2mtr
RS23	3mtr
RS24	4mtr
RS25	5mtr
RS26	6mtr
RS28	8mtr



W.L.L 3000KG (Yellow)	
CODE	LENGTH
RS31	1mtr
RS32	2mtr
RS33	3mtr
RS34	4mtr
RS35	5mtr
RS36	6mtr
RS38	8mtr



W.L.L 4000KG (Grey)	
CODE	LENGTH
RS41	1mtr
RS42	2mtr
RS43	3mtr
RS44	4mtr
RS45	5mtr
RS46	6mtr
RS48	8mtr



W.L.L 6000KG (Brown)	
CODE	LENGTH
RS63	3mtr
RS64	4mtr
RS66	6mtr









W.L.L 8000KG (Blue)	
CODE	LENGTH
RS83	3mtr
RS84	4mtr
RS88	8mtr



W.L.L 10000KG (Orange)	
CODE	LENGTH
RS102	2mtr
RS104	4mtr

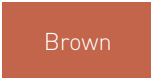

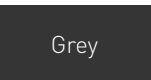













COLOUR CODING

CODE	W.L.L	CODE	W.L.L
 Violet	1 TONNE	 Red	5 TONNE
 Green	2 TONNE	 Brown	6 TONNE
 Yellow	3 TONNE	 Blue	8 TONNE
 Grey	4 TONNE	 Orange	10 TONNE

FLAT & ROUND SLINGS

CRANE

FLAT WEBBING & ROUND SLINGS (POLYESTER)

POLYESTER WEBBING SLINGS & ROUND SLINGS						
	VERTICAL	CHOKE	BASKET	BASKET	BASKET	
LIFTING MODE	W.L.L	W.L.L	W.L.L	30° W.L.L	60° W.L.L	
Colour Code	Kg	Kg	Kg	Kg	Kg	
 Violet	1000	800	2000	1900	1700	
 Green	2000	1600	4000	3800	3400	
 Yellow	3000	2400	6000	5700	5100	
 Grey	4000	3200	8000	7600	6800	
 Red	5000	4000	10000	9500	8500	
 Brown	6000	4800	12000	11400	10200	
 Blue	8000	6400	16000	15200	13600	
 Orange	10000	8000	20000	19000	17000	

CRANE's Great Range Of Hoisting Equipment Featuring Our **CRANE TOUGH CT - SERIES**



Built **Tough**, Super **Reliable**, and **Safe**.

Our range of hoisting equipment is built Tough and fitted with all the safety features and reliability to give you peace of mind.

The **CRANE CT Series** is ideal for both the professional users and home handyman and is backed by a 2 year Warranty.



HOISTING EQUIPMENTS

CRANE



High Strength Alloy Side Plates



Welded Structural Stay Bolts



Drop Forged Pinion Shaft



Caged & Sealed Roller Bearings



High Performance Blue Grease

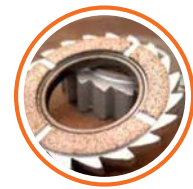

Zinc "Flake" Coating



Quick Hook Replacement Design



Hook Strength Pads



Sintered Brake System



Quick Adjust Free Spool Feature



Heavy Duty Cast Steel Safety Latch



Chain Stop Grip



CRANE

MINI LEVER BLOCKS

Super Compact & Light Weight

The new CT SERIES of lightweight MINI LEVER BLOCKS are all steel construction and impact resistant to ensure long life. This range includes Grade 100 chain which is not only lighter but 20% stronger than Grade 80 chain.

- Featuring the world's lightest lever block, our CT25 weighs only an unbelievable 1.5kg.
- The new style is super lightweight. Our mini lever blocks are all steel construction & impact resistant to ensure long life.
- The compact handle design, featuring the relaxed grip, has been developed using a uniquely engineered thermoplastic, so it's long lasting and reduces fatigue.
- 360° rotation swivel hook allows the operator to work in confined spaces easily.
- The **CRANE** advanced gear reduction system features 5 gears in the gear box and double pawl. Ensuring smooth performance and longer life.

✓ ALL QUALITY COMPONENTS

✓ POWDER COATED

External galvanneal plating process unique to the **CRANE** range of lifting equipment.



TECHNICAL PROPERTIES

Item No	W.L.L	Chain Grade	Chain Length	Unit Weight
CTMLB25	250kg	100	1.5m	1.5kg
CTMLB50	500kg	100	1.5m	2.5kg
CTMLB75	750kg	100	1.5m	3.4kg
CTMLB150	1500kg	100	1.5m	6.3kg

CRANE

LEVER BLOCKS

Heavy Duty Proven Reliability

The range of CT SERIES lever blocks is tough reliable and great value for money. There is a model to suit every need.

Ideal for the farmer, serious home handyman or professional user, it is so easy to use and is built to last, comes standard with grade 80 chain in 1.5metres some are available in 3metre lengths.

All of our CT series lever blocks have been designed to last and to meet and exceed the Australian standards AS1418.2 - 1997.

- The compact handle design, featuring the relaxed grip, has been developed using a uniquely engineered thermoplastic, so it's long lasting and reduces fatigue.
- 360° rotation swivel hook allows the operator to work in confined spaces easily.



✓ ALL QUALITY COMPONENTS

✓ POWDER COATED

External galvanneal plating process unique to the **CRANE** range of lifting equipment.



TECHNICAL PROPERTIES

Item No	W.L.L	Chain Grade	Chain Length	Unit Weight
CTLB80D	800kg	100	1.5m	5.7kg
CTLB160	1600kg	100	1.5m	8kg
CTLB163	1600kg	100	3m	9.6kg
CTLB320	3200kg	100	1.5m	13.6kg
CTLB323	3200kg	100	3m	17kg



CRANE CT - SERIES

LEVER BLOCKS

- ✓ ALL QUALITY COMPONENTS
- ✓ POWDER COATED
- External galvanneal plating process unique to the **CRANE** range of lifting equipment.



TECHNICAL PROPERTIES

Item No	W.L.L	Chain Grade	Chain Length	Unit Weight
CTLB25	250kg	80	1.5m	1.9kg
CTLB50	500kg	80	1.5m	2.45kg
CTLB80	800kg	80	1.5m	6.4kg
CTLB100	1000kg	100	1.5m	6.5kg

CRANE CT - SERIES

CHAIN BLOCKS

- ✓ ALL QUALITY COMPONENTS
- ✓ POWDER COATED
- External galvanneal plating process unique to the **CRANE** range of lifting equipment.



TECHNICAL PROPERTIES

Item No	W.L.L	Chain Grade	Chain Length	Unit Weight
CTCB503	500kg	80	3m	7.8kg
CTCB13	1000kg	80	3m	11.1kg
CTCB16	1000kg	80	6m	16kg
CTCB23	2000kg	80	3m	16.8kg
CTCB26	2000kg	80	6m	24kg
CTCB33	3000kg	80	3m	20kg
CTCB36	3000kg	80	6m	28kg
CTCB53	5000kg	80	3m	40kg



Electric Chain Hoisting Equipment

Single Phase with Emergency Stop Switch

CRANE Electric Chain Hoists are easy to operate, service, require minimal maintenance and offer excellent headroom for every lifting application.

Standard overload device protects the hoist, operator, and surrounding structure from damaging overloads.

Strong

- Electromagnetic brake holds a load even if power is interrupted.
- Upper and lower limit switches prevent over-travel.
- Built-in chain bag keeps chain out of the way during operation.
- Ventilated heavy-duty motor shuts down to prevent overheating.

Safe

- Single phase.
- Handheld remote control with emergency stop switch can be controlled up to 20 metres.
- Can be easily attached to most trolleys or beam clamps.
- Heat-treated, drop-forged hooks swivel 360° for easy rigging.

Reliable

- Quick-connect wiring connects power with push button controls for smooth operation.
- Permanently lubricated gear train delivers a long life with low maintenance.
- Integrated slip clutch ensures continuous duty and tension control and protects transmission from overload.



New Configuration:

Load Limiter is installed to prohibit the chain from overload..



Chain Protection Box:

Protects the Chain



Hook & Safety Latch:

Perfect Strength hook that is hard to break.



Control Switch:

Light and Durable Switch with Emergency Stop Button.



CRANE

ELECTRIC CHAIN HOIST

Single Phase with Emergency Stop Switch

- Load Limiter.
- Emergency Stop Switch.
- Thermal Overload Prevention.
- Light weight, compact design with high efficiency motor.
- Pressed steel structure, high strength body.
- High tensile alloy steel top & bottom hooks.
- Grade 80 – 7.1mm Alloy Steel load chain.
- Limit switches fitted at top and bottom ends to prevent chain runaway.
- Complies with ASNZS 1418.2 standard.
- The electric chain hoist offers a long and reliable operation.
- Compact structure, light weight, easily operation and attractive appearance.
- Single Phase.



ALL QUALITY COMPONENTS



POWDER COATED



G80 7.1MM ALLOY CHAIN



External galfusion plating process unique to the **CRANE** range of lifting equipment.



TECHNICAL PROPERTIES

Item No	W.L.L	Chain Grade	Running Test Load	Standard Length	Lifting Speed	Unit Weight
CEH13	1000kg	80	12.5kN	3m	6m/min	55kg
CEH16	1000kg	80	12.5kN	6m	6m/min	58kg
CEH23	2000kg	80	25kN	3m	3m/min	62kg
CEH26	2000kg	80	25kN	6m	3m/min	69kg

CRANE

MATERIAL HANDLING

MATERIAL HANDLING

CRANE



MAGNETIC LIFTERS

CODE	DESCRIPTION	LIFTING CAPACITY
CML300	Magnetic lifter	300kg
CML600	Magnetic lifter	600kg

- **CRANE** permanent Magnetic lifters are very lightweight and compact in design. Ideal for lifting and handling steel plate, beams, pipes, and cylindrical work pieces.
- These lifters are widely used for lifting and hoisting in factories, warehouses, on wharfs and transport facilities.
- The high magnetic properties of the **CRANE** magnetic lifter enable the design to be more compact relative to other products with the same lifting capacity.
- As the **CRANE** Permanent Magnetic lifter is not electrically operated this allows for both indoor and outdoor use without the need for power supply.
- A round bar must contact the V shape slot at the bottom of the lifting magnet.
- When lifting pipes, its thickness should also be taken into account.
- Another benefit is no accidents can happen by the sudden loss of power failure.
- Safe and easy to use in temperatures from -20° C to +60° C.



1000KG - 2000KG CRANE SCALES

MODEL	MEASURING RANGE	UNIT WEIGHT
CSXS1	0-1000kg	10
CSXS2	0-2000kg	12



Crane scales are a compact measuring device for weighing loads during lifting.

- 36mm LCD display
- Fully rechargeable
- Full tare function
- Displays in Kg or Lb
- Shows battery life

Please Note these scales are used for weighing not to be used as a full on lifting device.

LIFTING CLAMPS

MATERIAL HANDLING



HORIZONTAL CLAMPS					
CODE	W.L.L	JAW SIZE OPENING	TOTAL OVERALL LENGTH	TOTAL OVERALL WIDTH	TOP HOLE DIAMETER
CLCH1	1 Tonne	0-35mm	210mm	50mm	25mm
CLCH2	2 Tonne	0-50mm	235mm	60mm	25mm

CRANE



VERTICAL PLATE CLAMPS					
CODE	W.L.L	JAW SIZE OPENING	TOTAL OVERALL LENGTH	TOTAL OVERALL WIDTH	TOP HOLE DIAMETER
CLCV1	1 Tonne	0-20mm	290mm	60mm	45mm
CLCV2	2 Tonne	0-25mm	380mm	75mm	50mm



UNIVERSAL PLATE CLAMPS					
CODE	W.L.L	JAW SIZE OPENING	TOTAL OVERALL LENGTH	TOTAL OVERALL WIDTH	TOP HOLE DIAMETER
25263	3 Tonne	0-30mm	425mm	90mm	60mm
25265	5 Tonne	0-40mm	500mm	100mm	70mm

CRANE CT - SERIES

BEAM CLAMPS

- **CRANE** Beam Clamps are designed to work hand-in-hand with our chain and lever hoists.
- Fully adjustable.
- Clamps are smooth and robust, allowing easy manual handling to use.

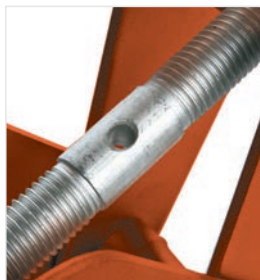

MATERIAL HANDLING

CRANE

TECHNICAL PROPERTIES

MODEL		CBC1	CBC2	CBC3	CBC4
Capacity (Tonne)		1 T	2 T	3 T	4 T
Dimensions (mm)	A (max.)	260	260	354	354
	B (min.)	180	180	235	235
	B (max.)	360	360	490	490
	C	64	74	103	110
	D	5	6	8	10
	E	215	215	260	260
	F (max.)	155	155	225	225
	F (min.)	102	102	140	140
	G	25	25	45	45
	H	22	22	24	28
Jaw Opening (mm)		75-220	75-220	80-320	80-320
Net weight (kg)		4.0	4.6	9.1	11.0

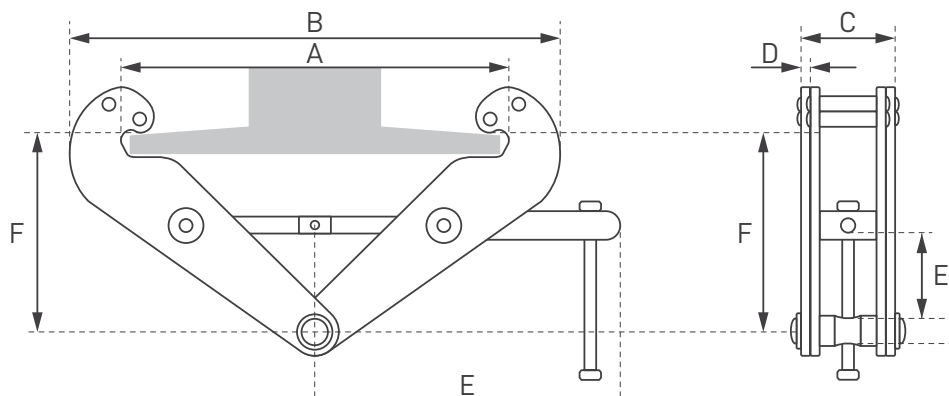



CRANE CT -SERIES

GIRDER TROLLEYS

- **CRANE** Girder Trolleys are designed to last and come with a 2-year replacement warranty. Both our Push type & Geared girder trolleys are operationally tested to 150% of the rated capacity and come with test certificates Strong & robust design provides long life and are both very easy to set up & use. Easy to adjust to suit a wide range of beams from 75mm -200 mm.



TECHNICAL PROPERTIES

MODEL		CT01	CT02	CGGT1	CGGT2
Capacity (Tonne)		1 T	2 T	1T	2T
Min radius of curve (metres)		1.0	1.1	1T	2T
Dimensions (mm)	A	296	313	354	340
	B	257	300	250	270
	C	181	214.5	214	227
	E	11	14	11	14
I-Beam Width Range (mm)		75-180	100-200	75-180	100-200
Net weight (kg)		12.8	18.8	10	15

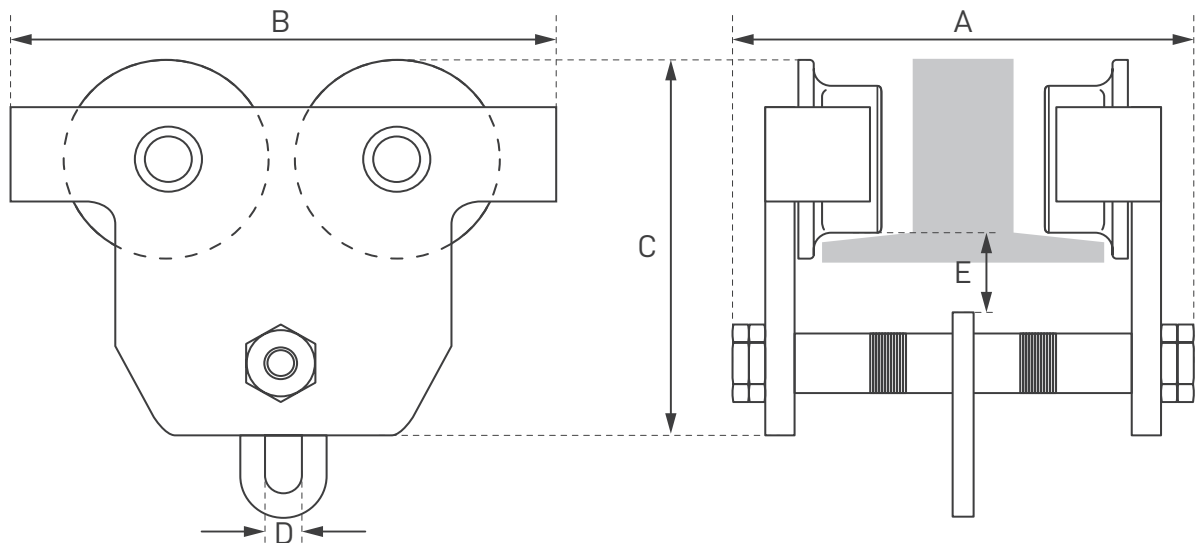

GRANGE

“Move with Confidence”

Features our Load Restraint & Transport Gear which once again you can be assured of top-quality products exceeding the Australian & New Zealand Tough Standards.

Which includes proper weldable Black Steel Trailer Safety Chain, Grade70 Gold Transport Chain & Grade 70 Components, Grange Drag Chain Kits & Load Restraint Kits, and 6mm – 13mm Ratchet Load Binders as well as the quality assured range of chains being Australian Short & Long Link Chain, Grade L Anchor Chain, Stainless Steel 316 Chain in 6, 8, & 10mm. Rounding out our Grange Range is our Top Quality Hi Vis Ratchet Tie Down Range starting from 25mm – 75mm in width and available in a range of lengths ranging from 3metres -12metres, plus our new Automatic Quick release Style Ratchet tie downs.

01 Ratchet Tie Downs 36

02 Ratchets & Straps 37

03 Load Restraints 38

04 Chains 41

RATCHET TIE DOWNS

RATCHET TIE DOWNS

GRANGE



RATCHET TIE DOWN S HOOK			
CODE	SIZE	LENGTH	LASHING CAPACITY
GR275S	27mm	5m	750kg
GR385S	38mm	5m	1000kg



RATCHET TIE DOWN HOOK & KEEPER			
CODE	SIZE	LENGTH	LASHING CAPACITY
GR275HK	27mm	5m	750kg
GR385HK	38mm	5m	1500kg
GR506HK	50mm	6m	2500kg
GR509HK	50mm	9m	2500kg
GR512HK	50mm	12m	2500kg



RATCHET TIE DOWN J HOOK			
CODE	SIZE	LENGTH	LASHING CAPACITY
GR7510J	75mm	10m	4000kg

- Weather & abrasion resistant
- Heavy duty ratchet buckle
- Heavy duty J hook and keeper

**MORE RATCHETS AVAILABLE IN SCHUTTS CARGO SECTION
CONTACT US IF YOU REQUIRE CUSTOM-MADE RATCHETS**

RATCHETS & STRAPS



AUTOMATIC QUICK RELEASE S HOOKS			
CODE	SIZE	LENGTH	LASHING CAPACITY
GRQR25S	25mm	3.5m	320kg
GRQR38S	38mm	4m	500kg
GRQR50S	50mm	4.5m	750kg

● Grange new style of Automatic Quick Release Ratchet Tie Downs is simply awesome. With a built-in safety mechanism that quickly winds the strap back in until the last metre so you can never get hit by the hook as it then slowly winds in for complete and safe control. Available in three sizes 25mm, 38mm, & 50mm. For a no hassle ratchet you can't go past.



REPLACEMENT STRAP			
CODE	SIZE	LENGTH	LASHING CAPACITY
GRS509	50mm	9m	2500 kg
GRS512	50mm	12m	2500 kg
GRS7510	75mm	9m	5000 kg

● Heavy duty hook and keeper



LUGGAGE STRAP		
CODE	SIZE	LENGTH
GLSAB	50mm	1.8m

● This is Ideal for suitcases and can be used for a general-purpose strap with easy click in & click out buckle. Total Length is 1800mm x 50mm wide.



CLIP-ON TRUCK WINCHES			
CODE	WIDTH	LENGTH	LASHING CAPACITY
LC2500	50mm	9m	2500 kg

- Clip-on winch c/w 9m strap
- Heavy duty hook and keeper
- Keep it tight - not loose
- Ensure gear teeth are in good condition
- Ensure arms are straight not bent
- Make certain appropriate winch is used
- When in use, ensure that at least 3 loops of webbing remain on winch drum

LOAD RESTRAINTS

LOAD RESTRAINTS



GRANGE TOW KIT		
CODE	SIZE	TOWING CAPACITY
GTK2	6mm	0 - 2 Tonne
GTK4	8mm	0 - 4 Tonne

- GRANGE offers two models of tow kits, both complete with easy-to-use instructions for safely fitting to any tow bar. The 6mm GTK2 is rated for 2.2 tons, while the GTK4 can handle up to 4 tons.
- GRANGE offers two models of tow kits, both complete with easy-to-use instructions for safely fitting to any tow bar. The 6mm GTK2 is rated for 2.2 tons, while the GTK4 can handle up to 4 tons.

GRANGE



GRANGE TOW KIT MERCHANDISER		
CODE	SIZE	TOWING CAPACITY
GTK2BX	6mm	0 - 2 Tonne

- GTK2BX (BOX OF 20)
- GRANGE offers two models of tow kits, both complete with easy-to-use instructions for safely fitting to any tow bar. The 6mm GTK2 is rated for 2.2 tons.
- Grade 80 Components tested & certified to AS3776-2015.
- 2 Tonne suits 8mm chain.



GRANGE TOW KIT MERCHANDISER		
CODE	SIZE	TOWING CAPACITY
GTK4BX	8mm	0 - 4 Tonne

- GTK4BX (BOX OF 15)
- GRANGE offers two models of tow kits, both complete with easy-to-use instructions for safely fitting to any tow bar. The 8mm GTK4 can handle up to 4 tons.
- Grade 80 Components tested & certified to AS3776-2015.
- 4 Tonne suits 10mm & 13mm chain.

LOAD RESTRAINTS

LOAD RESTRAINTS

GRANGE



LOADBINDER RATCHET

CODE	SIZE	LASHING CAPACITY
GL70RL06	6mm	2300 kg
GL70RL08	7/8mm	3800 kg
GL70RL10	10mm	6000 kg
GL70RL13	13mm	9000 kg

- Manufactured from dropped forged steel
- Winged hooks



GRADE 70 LOAD RESTRAINT KIT

CODE	CHAIN SIZE	LENGTH	LASHING CAPACITY
GLRK86	8mm	6m	3800 kg
GLRK89	8mm	9m	3800 kg
GLRK106	10mm	6m	6000 kg
GLRK109	10mm	9m	6000 kg

- Winged grab hooks, each end
- Gold zinc plated
- Grange Lift Load restraint kits come in a handy reusable carry box.



GRADE 70 DRAG CHAIN KITS

CODE	SIZE	LENGTH
GDCK8	8mm	5m
GDCK10	10mm	5m

- GRANGE Drag Chain Kits come in two sizes 8mm x 5metre & 10mm X 5 metre both feature Grade70 Transport chain with a Fitted Lug Link & Clevis Grab Hook.

LOAD RESTRAINTS

LOAD RESTRAINTS

GRANGE



GRADE 70 CLEVIS GRAB HOOK

CODE	SIZE	LASHING CAPACITY
GL70H06	6mm	2300 kg
GL70H08	7/8mm	3800 kg
GL70H10	10mm	6000 kg
GL70H13	13mm	9000 kg

- Winged
- Gold zinc plated



GRADE 70 CLEVIS SLIP HOOK

CODE	SIZE	LASHING CAPACITY
GL70S06	6mm	2300 kg
GL70S08	7/8mm	3800 kg
GL70S10	10mm	6000 kg
GL70S13	13mm	9000 kg

- Gold zinc plated

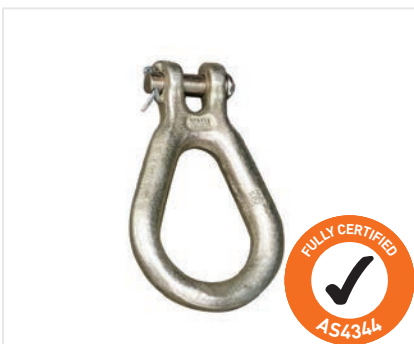

GRADE 70 CLEVIS LUG LINK

CODE	SIZE	LASHING CAPACITY
GLL7008	7/8mm	3800 kg
GLL7010	10mm	6000 kg
GLL7013	13mm	9000 kg

- Gold zinc plated

CHAINS



Available in Grade 70, 80, 100



Supplied tested and certified



Meets Australian Standard



Available in a range of lengths and fittings



Other sizes, configurations and capacities available

CHAINS

GRANGE

Chain Overview

	Grade	Name	Standard	Overhead Lifting	Material
	Grade 50	AUS Short Link & Long Link	AS2321	No	Alloy Steel
	Grade 70	Transport Chain	AS4344	No	Carbon Steel
	Grade 316	Stainless Steel	AS4797	No	316 Reg Link
	-	Trailer Safety Chain	AS4177	No	Black Steel



GRADE 50 AUS GAL SHORT LINK CHAIN BUCKET

CODE	CHAIN SIZE	W.L.L	INSIDE LINK		OUTSIDE LINK		QTY IN 25KG BUCKET	QTY IN 50KG BUCKET
			LENGTH	WIDTH	LENGTH	WIDTH		
GSLC5B	5mm	250kg	20mm	9mm	30mm	18mm	100m	-
GSLC6B	6mm	320kg	18.5mm	8mm	30.5mm	20mm	33m	-
GSLC8B	8mm	530kg	24mm	11mm	40mm	27mm	-	36m
GSLC10B	10mm	830kg	30mm	14mm	50mm	34mm	-	23m

GRADE 50 AUS GAL SHORT LINK CHAIN DRUM

CODE	CHAIN SIZE	W.L.L	INSIDE LINK		OUTSIDE LINK		QTY IN 500KG DRUM
			LENGTH	WIDTH	LENGTH	WIDTH	
GSLC13D	13mm	1.5t	39mm	19.5mm	65mm	45mm	134m

● This Aus Gal Short Link Chain is ideal for Marine & Mooring and as A Anchor Chain as it has a Higher Breaking load limit than Grade L Chain and the Hot Dip Galvanised Finish guarantees excellent protection against Corrosion & Abrasion.

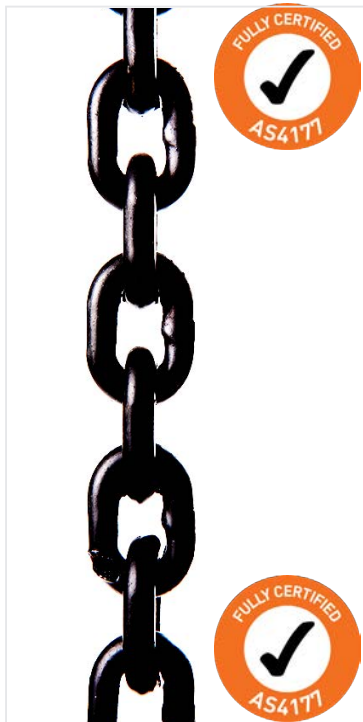

TRAILER SAFETY CHAIN BUCKET - BLACK STEEL FULLY WELDABLE							
CODE	CHAIN SIZE	W.L.L	INSIDE LINK		OUTSIDE LINK		QTY IN 50KG BUCKET
			LENGTH	WIDTH	LENGTH	WIDTH	
GTSC8B	8mm	2000kg	24mm	11.5mm	39.5mm	26.8mm	45m
GTSC10B	10mm	2500kg	30mm	14.2mm	44.7mm	33.3mm	29m
GTSC13B	13mm	3500kg	39.1mm	18.8mm	64.5mm	43.7mm	15m

TRAILER SAFETY CHAIN DRUM - BLACK STEEL FULLY WELDABLE									
CODE	CHAIN SIZE	W.L.L	INSIDE LINK		OUTSIDE LINK		QTY IN 125KG DRUM	QTY IN 250KG DRUM	QTY IN 500KG DRUM
			LENGTH	WIDTH	LENGTH	WIDTH			
GTSC8D	8mm	2000kg	24mm	11.5mm	39.5mm	26.8mm	-	450m	-
GTSC10D	10mm	2500kg	30mm	14.2mm	44.7mm	33.3mm	290m	-	-
GTSC13D	13mm	3500kg	39.1mm	18.8mm	64.5mm	43.7mm	-	-	140m



GRADE 316 STAINLESS STEEL CHAIN BUCKET							
CODE	CHAIN SIZE	INSIDE LINK		OUTSIDE LINK		QTY IN 25KG BUCKET	QTY IN 50KG BUCKET
		LENGTH	WIDTH	LENGTH	WIDTH		
GSSC6B	6mm	29mm	13mm	34mm	21mm	72m	-
GSSC8B	8mm	34mm	18mm	48mm	37mm	-	38m
GSSC10B	10mm	42mm	20mm	60mm	37mm	-	25m



GRADE 70 TRANSPORT CHAIN BUCKET								
CODE	CHAIN SIZE	LASHING CAPACITY	INSIDE LINK		OUTSIDE LINK		QTY IN 25KG BUCKET	QTY IN 50KG BUCKET
			LENGTH	WIDTH	LENGTH	WIDTH		
GTC6B	6mm	2300kg	17.6mm	8.6mm	29.4mm	20.3mm	63m	-
GTC8B	8mm	3800kg	23.6mm	11.4mm	39.1mm	27.3mm	-	36m
GTC10B	10mm	6000kg	29.9mm	14.3mm	49.4mm	33.3mm	-	23m
GTC13B	13mm	9000kg	39mm	18.3mm	64.1mm	43.1mm	-	14m

GRADE 70 TRANSPORT CHAIN DRUM							
CODE	CHAIN SIZE	LASHING CAPACITY	INSIDE LINK		OUTSIDE LINK		QTY IN 500KG DRUM
			LENGTH	WIDTH	LENGTH	WIDTH	
GTC6D	6mm	2300kg	17.6mm	8.6mm	29.4mm	20.3mm	630m
GTC8D	8mm	3800kg	23.6mm	11.4mm	39.1mm	27.3mm	360m
GTC10D	10mm	6000kg	29.9mm	14.3mm	49.4mm	33.3mm	230m
GTC13D	13mm	9000kg	39mm	18.3mm	64.1m	43.1mm	140m



PROTEX[®]

PROTEX is a Premium Quality Manufacturer & has now become the worlds No.1 Manufacturer of over centre latches and is the world's largest supplier of standard range in toggle latches & Draw latches & Quick Release Band Clamps. Protex is a UK company founded in 1954.

01 Light Duty **44**

02 Medium Duty **48**

03 Heavy Duty **53**

04 Catchbolts **54**

05 Bandclamps **55**

LIGHT DUTY

Non-Adjustable Toggle Latch

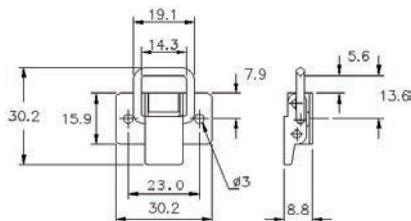
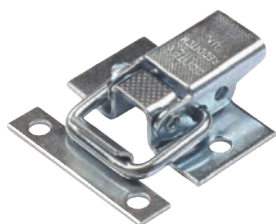

Catchplates



01-589MSZN

SKU	MATERIAL	FINISH	HOLE Ø	WEIGHT	LOCKABLE	SAFETY	SPRING	STRENGTH
10-589MSZN	Mild Steel	Zinc	3.00mm	0.0084kg	No	No	N/A	35kg

Non-Adjustable Toggle Latch

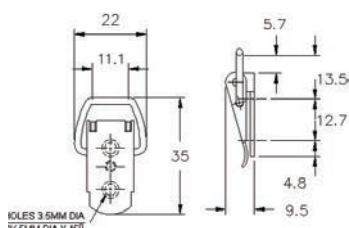

Catchplates



01-531SS

03-531SS

SKU	MATERIAL	FINISH	HOLE Ø	WEIGHT	LOCKABLE	SAFETY	SPRING	STRENGTH
15-531SS	Stainless	Natural	3.50mm	0.0092kg	No	No	N/A	125kg

Spring Claw Toggle Latch

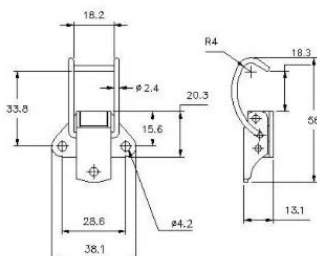

Catchplates

N/A

SKU	MATERIAL	FINISH	HOLE Ø	WEIGHT	LOCKABLE	SAFETY	SPRING	STRENGTH
18-1345SS	Stainless	Natural	4.20mm	0.0228kg	No	No	N/A	60kg

Spring Claw Toggle Latch

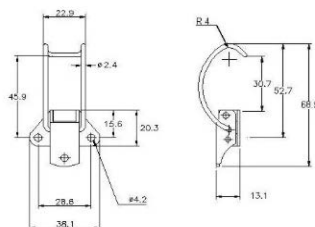

Catchplates

N/A

SKU	MATERIAL	FINISH	HOLE Ø	WEIGHT	LOCKABLE	SAFETY	SPRING	STRENGTH
18-1645MSZN	Mild Steel	Zinc	4.10mm	0.0246kg	No	No	N/A	80kg

Also Available Our Best-selling Catch Plates!



01-504MSZN



01-502MSZN



01-655CSZN/YP



03-655CSZN/YP

Non-Adjustable Toggle Latch

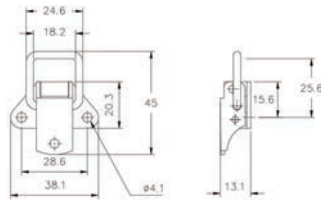

Catchplates



SKU	MATERIAL	FINISH	HOLE Ø	WEIGHT	LOCKABLE	SAFETY	SPRING	STRENGTH
18-613MSZN	Mild Steel	Zinc	4.10mm	0.0230kg	No	No	N/A	195kg
18-613SS	Stainless	Natural	4.10mm	0.0231kg	No	No	N/A	300kg

Non-adjustable Toggle Latch

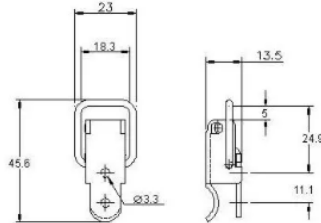

Catchplates



SKU	MATERIAL	FINISH	HOLE Ø	WEIGHT	LOCKABLE	SAFETY	SPRING	STRENGTH
20-1658MSZN	Mild Steel	Zinc	3.30mm	0.0195kg	No	No	N/A	170kg

Spring Claw Toggle Latch

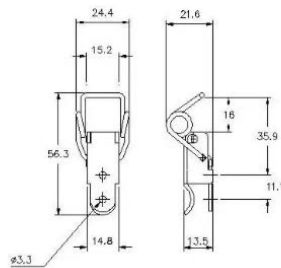

Catchplates



SKU	MATERIAL	FINISH	HOLE Ø	WEIGHT	LOCKABLE	SAFETY	SPRING	STRENGTH
20-50414GMSZN	Mild Steel	Zinc	3.30mm	0.0217kg	No	No	19kg @4.0mm	90kg
20-50414GSS	Stainless	SF	3.30mm	0.0211kg	No	No	16kg@4.0	90kg
20-504MSZN	Mild Steel	Zinc	3.30mm	0.0217kg	No	No	19kg@4.0mm	90kg
20-504SS	Stainless	SF	3.30mm	0.0217kg	No	No	16kg@4.0mm	90kg

Non-adjustable Toggle Latch

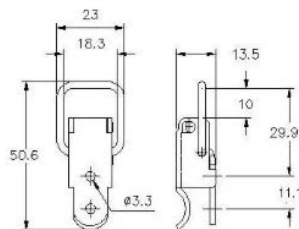

Catchplates



SKU	MATERIAL	FINISH	HOLE Ø	WEIGHT	LOCKABLE	SAFETY	SPRING	STRENGTH
20-505MSZN	Mild Steel	Zinc	3.30mm	0.0194	No	No	N/A	170kg

Also Available Our Best-selling Catch Plates!



LIGHT DUTY

PROTEX

Spring Claw Toggle Latch

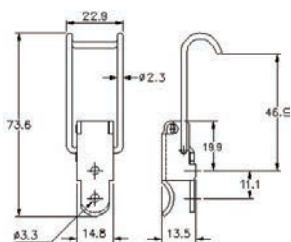

Catchplates

N/A

SKU	MATERIAL	FINISH	HOLE Ø	WEIGHT	LOCKABLE	SAFETY	SPRING	STRENGTH
20-522MSZN	Mild Steel	Zinc	3.30mm	0.0223kg	No	No	68kg@5.0mm	90kg
20-522SS	Stainless	SF	3.30mm	0.0219kg	No	No	22kg@2.0mm	90kg

Non-Adjustable Toggle Latch

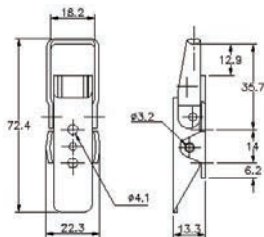

Catchplates



03-1123SS

03-1123MSZN

SKU	MATERIAL	FINISH	HOLE Ø	WEIGHT	LOCKABLE	SAFETY	SPRING	STRENGTH
27-1123MSZN	Mild Steel	Zinc	4.10mm	0.0419kg	No	No	N/A	200kg
27-1123SS	Stainless	Natural	4.10mm	0.0415kg	No	No	N/A	300kg

Spring Claw Toggle Latch

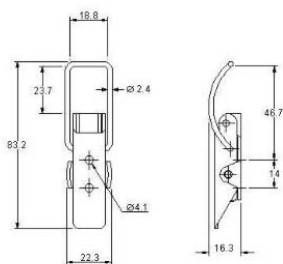

Catchplates



001-600CLR

03-633MSZN

SKU	MATERIAL	FINISH	HOLE Ø	WEIGHT	LOCKABLE	SAFETY	SPRING	STRENGTH
27-1162MSZN	Mild Steel	Zinc	4.10mm	0.0356kg	No	No	54kg @	90kg
27-1162SS	Stainless	SF	4.10mm	0.0349kg	No	No	22kg @	90kg

Spring Claw Toggle Latch

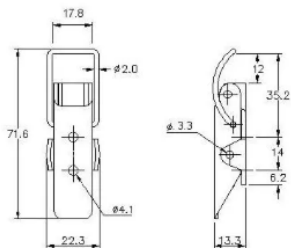

Catchplates



01-600CLR

02-633MSZN

SKU	MATERIAL	FINISH	HOLE Ø	WEIGHT	LOCKABLE	SAFETY	SPRING	STRENGTH
27-633MSZN	Mild Steel	Zinc	4.10mm	0.0337kg	No	No	N/A	90kg
27-633SS	Stainless	Natural	4.10mm	0.0329kg	No	No	N/A	90kg

Also Available Our Best-selling Catch Plates!



01-504MSZN



01-502MSZN



01-655CSZN/YP



03-655CSZN/YP

Spring Claw Toggle Latch

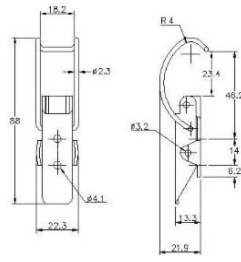

Catchplates

N/A

SKU	MATERIAL	FINISH	HOLE Ø	WEIGHT	LOCKABLE	SAFETY	SPRING	STRENGTH
27-645SEALSS	Stainless	Natural	4.10mm	0.0384kg	No	No	N/A	50kg

Spring Claw Toggle Latch

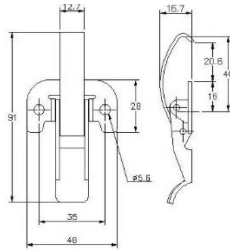

Catchplates



04-1115MSZN

SKU	MATERIAL	FINISH	HOLE Ø	WEIGHT	LOCKABLE	SAFETY	SPRING	STRENGTH
28-1115MSZN	Mild Steel	Zinc	5.50mm	0.0451kg	No	No	N/A	100kg

Spring Claw Toggle Latch

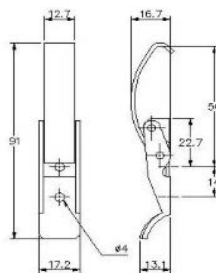

Catchplates



04-2150MSZN

SKU	MATERIAL	FINISH	HOLE Ø	WEIGHT	LOCKABLE	SAFETY	SPRING	STRENGTH
28-2150MSZN	Mild Steel	Zinc	4.10mm	0.04kg	No	No	N/A	100kg

Adjustable Toggle Latch

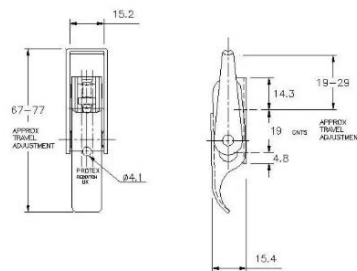

Catchplates



01-535MSZN



02-535MSZN



02-535SS

SKU	MATERIAL	FINISH	HOLE Ø	WEIGHT	LOCKABLE	SAFETY	SPRING	STRENGTH
50-1535MSZN	Mild Steel	Zinc	4.10mm	0.0455kg	No	No	N/A	200kg
50-1535SS	Stainless	Natural	4.10mm	0.0451kg	No	No	N/A	300kg

Also Available Our Best-selling Catch Plates!



01-504MSZN



01-502MSZN



01-655CSZN/YP



03-655CSZN/YP

LIGHT DUTY

PROTEX

MEDIUM DUTY

MEDIUM DUTY

PROTEX

Spring Claw Toggle Latch

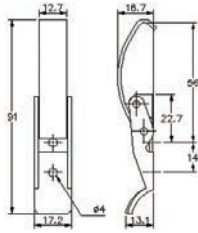

Catchplates

N/A

SKU	MATERIAL	FINISH	HOLE Ø	WEIGHT	LOCKABLE	SAFETY	SPRING	STRENGTH
28-2150MSZN	Mild Steel	Zinc	4.10mm	0.0400kg	No	No	70kg@3.2mm	100kg

Non-Adjustable Latch

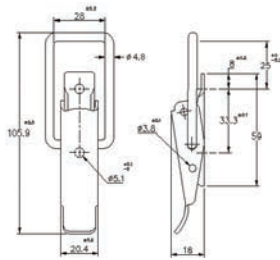

Catchplates



01-502MSZN

03-602SS

SKU	MATERIAL	FINISH	HOLE Ø	WEIGHT	LOCKABLE	SAFETY	SPRING	STRENGTH
30-502MSZN	Mild Steel	Zinc	5.10mm	0.0756kg	No	No	N/A	450kg
30-502SS	Stainless	SF	5.10mm	0.0695kg	No	No	N/A	550kg

Non-Adjustable Latch

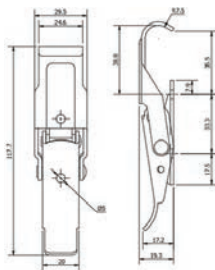

Catchplates

N/A

SKU	MATERIAL	FINISH	HOLE Ø	WEIGHT	LOCKABLE	SAFETY	SPRING	STRENGTH
30-506MSZN	Mild Steel	Zinc	5.10mm	0.0926kg	No	No	N/A	300kg

Spring Claw Latch

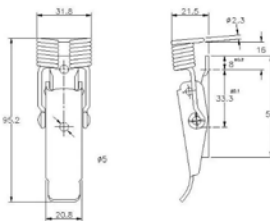

Catchplates



01-502MSZN

01-502SS

SKU	MATERIAL	FINISH	HOLE Ø	WEIGHT	LOCKABLE	SAFETY	SPRING	STRENGTH
30-521MSZN	Mild Steel	Zinc	5.10mm	0.0774kg	No	No	40kg	100kg

Also Available Our Best-selling Catch Plates!



01-504MSZN

01-502MSZN

01-655CSZN/YP

03-655CSZN/YP

Non-Adjustable Latch

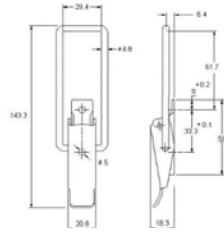

Catchplates



01-502MSZN 01-502SS

SKU	MATERIAL	FINISH	HOLE Ø	WEIGHT	LOCKABLE	SAFETY	SPRING	STRENGTH
30-560MSZN	Mild Steel	Zinc	5.10mm	0.0868kg	No	No	N/A	450kg
30-560SS	Stainless	Natural	5.10mm	0.08kg	No	No	N/A	550kg

Non-Adjustable Padlockable Latch

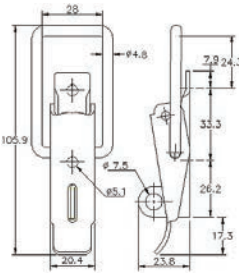

Catchplates



01-502MSZN 03-1260SS

SKU	MATERIAL	FINISH	HOLE Ø	WEIGHT	LOCKABLE	SAFETY	SPRING	STRENGTH
30-570MSZN	Mild Steel	Zinc	5.10mm	0.0763kg	Yes	No	N/A	450kg
30-570SS	Stainless	Natural	5.10mm	0.0719kg	Yes	No	N/A	550kg

Non-Adjustable Latch

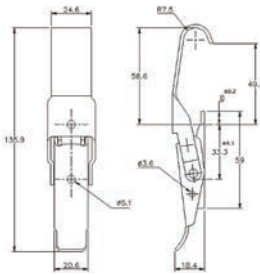

Catchplates

N/A

SKU	MATERIAL	FINISH	HOLE Ø	WEIGHT	LOCKABLE	SAFETY	SPRING	STRENGTH
30-585MSZN	Mild Steel	Zinc	5.10mm	0.1023kg	No	No	N/A	200kg
30-585SS	Stainless	Natural	5.10mm	0.0969kg	No	No	N/A	125kg

Non-Adjustable Latch

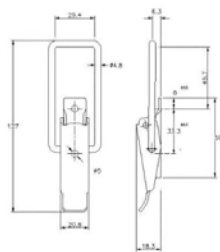

Catchplates



01-502SS 03-1260SS

SKU	MATERIAL	FINISH	HOLE Ø	WEIGHT	LOCKABLE	SAFETY	SPRING	STRENGTH
30-588LPSS	Stainless	Natural	5.10mm	0.0764kg	No	No	No	550kg

Also Available Our Best-selling Catch Plates!



01-504MSZN 01-502MSZN 01-655CSZN/YP 03-655CSZN/YP

MEDIUM DUTY

PROTEX

Non-Adjustable Latch

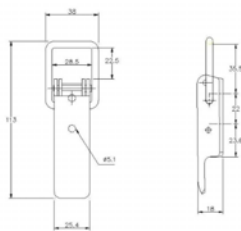

Catchplates



01-502MSZN 03-1260MSZN

SKU	MATERIAL	FINISH	HOLE Ø	WEIGHT	LOCKABLE	SAFETY	SPRING	STRENGTH
33-1260MSZN	Mild Steel	Zinc	5.10mm	0.1089kg	No	No	No	450kg

Non-Adjustable Latch

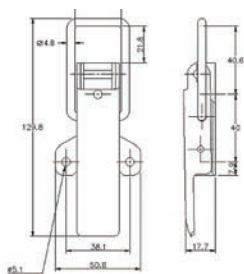

Catchplates



01-502MSZN 03-1260MSZN 06-1058MSZN

SKU	MATERIAL	FINISH	HOLE Ø	WEIGHT	LOCKABLE	SAFETY	SPRING	STRENGTH
35-1058MSZN	Mild Steel	Zinc	5.10mm	0.1250kg	No	No	N/A	450kg
35-1058SS	Stainless	Natural	5.10mm	0.1236kg	No	No	N/A	550kg

Spring Claw Latch

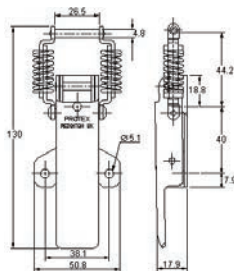

Catchplates



01-502SS 03-1260SS 06-1058SS

SKU	MATERIAL	FINISH	HOLE Ø	WEIGHT	LOCKABLE	SAFETY	SPRING	STRENGTH
35-1163SS	Stainless	Natural	5.10mm	0.1416kg	No	No	45kg@5.0mm	45kg

Spring Claw Latch

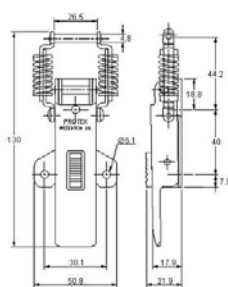

Catchplates



01-502MSZN 03-1260MSZN 06-1058MSZN

SKU	MATERIAL	FINISH	HOLE Ø	WEIGHT	LOCKABLE	SAFETY	SPRING	STRENGTH
36-1163SS	Stainless	Natural	5.10mm	0.1442kg	No	Yes	45kg@5.0mm	45kg

Also Available Our Best-selling Catch Plates!



01-504MSZN 01-502MSZN 01-655CSZN/YP 03-655CSZN/YP

Non-Adjustable Latch

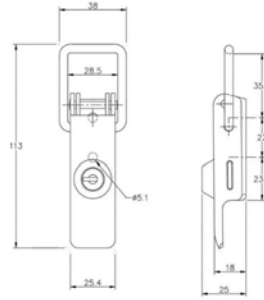

Catchplates



01-502MSZN 03-1260MSZN 06-1058MSZN

SKU	MATERIAL	FINISH	HOLE Ø	WEIGHT	LOCKABLE	SAFETY	SPRING	STRENGTH
373-1260SLMSZN	Mild Steel	Natural	5.10mm	0.138kg	No	Yes	N/A	450kg

Adjustable Latch

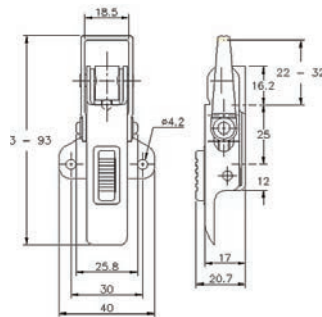

Catchplates



01-655CSZN/YP 01-655SS

SKU	MATERIAL	FINISH	HOLE Ø	WEIGHT	LOCKABLE	SAFETY	SPRING	STRENGTH
60-655M1MSZN/YP	Mild Steel	YP	4.20mm	0.0748kg	No	No	N/A	350kg

Adjustable Latch with Safety Catch

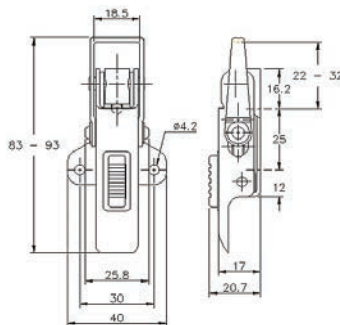

Catchplates



01-655CSZN/YP 01-655SS

SKU	MATERIAL	FINISH	HOLE Ø	WEIGHT	LOCKABLE	SAFETY	SPRING	STRENGTH
61-655M1MSZN/YP	Mild Steel	YP	4.20mm	0.0772kg	No	Yes	N/A	400kg
61-655M1SS	Stainless	Natural	4.20mm	0.0776kg	No	Yes	N/A	350kg

Also Available Our Best-selling Catch Plates!



01-504MSZN 01-502MSZN 01-655CSZN/YP 03-655CSZN/YP

MEDIUM DUTY

PROTEX

Adjustable Latch with Safety Catch

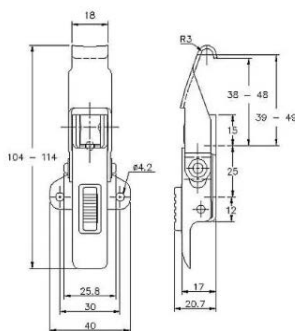

Catchplates



01-658SS

SKU	MATERIAL	FINISH	HOLE Ø	WEIGHT	LOCKABLE	SAFETY	SPRING	STRENGTH
61-658M1SS	Stainless	Natural	4.2mm	0.903kg	No	Yes	N/A	175kg

Adjustable Latch

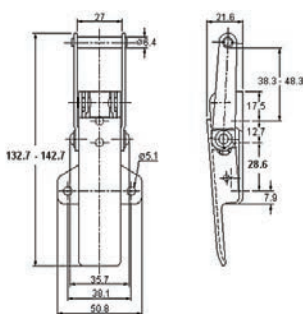

Catchplates



01-1273CSZN



01-1273SS

SKU	MATERIAL	FINISH	HOLE Ø	WEIGHT	LOCKABLE	SAFETY	SPRING	STRENGTH
70-1273MSZN/YP	Mild Steel	YP	5.10mm	0.1608kg	No	No	N/A	650kg

Non-adjustable Latch

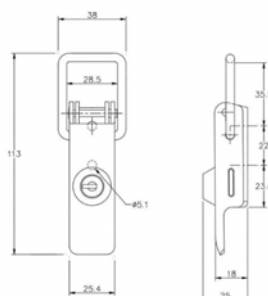

Catchplates



01-502MSZN



03-1260MSZN

SKU	MATERIAL	FINISH	HOLE Ø	WEIGHT	KEY	SAFETY	SPRING	STRENGTH
373-1260MSZN	Mild Steel	Zinc	5.10mm	0.138kg	Yes	No	N/A	450kg
373-1260SS	Stainless	Natural	5.10mm	0.1371kg	Yes	No	N/A	550kg

ALSO AVAILABLE: OUR BEST-SELLING CATCH PLATES!



01-504MSZN



01-502MSZN



01-655CSZN/YP



03-655CSZN/YP

HEAVY DUTY

Adjustable Toggle Latch Padlockable

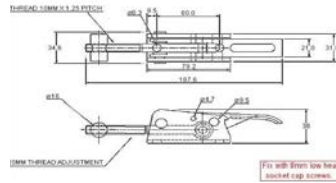

Catchplates



04-4000

SKU	MATERIAL	FINISH	HOLE Ø	WEIGHT	LOCKABLE	SAFETY	SPRING	STRENGTH
43-3000MSZN	Mild Steel	Zinc	8.30mm	0.4159kg	Yes	No	N/A	2000kg
43-3000SS	Stainless	Natural	8.30mm	0.4119kg	Yes	No	N/A	2500kg

Adjustable Toggle Latch

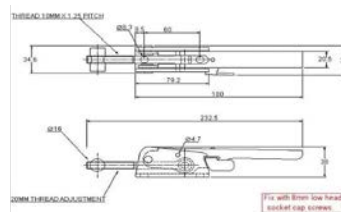

Catchplates



04-4000

SKU	MATERIAL	FINISH	HOLE Ø	WEIGHT	LOCKABLE	SAFETY	SPRING	STRENGTH
44-4000MSZN	Mild Steel	Zinc	8.30mm	0.4909kg	No	Yes	N/A	2000kg
44-4000SS	Stainless	Natural	8.30mm	0.4814kg	No	Yes	N/A	2500kg

Adjustable Toggle Latch

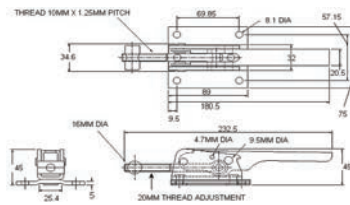

Catchplates



04-4292MSZN

SKU	MATERIAL	FINISH	HOLE Ø	WEIGHT	LOCKABLE	SAFETY	SPRING	STRENGTH
43-4292MSZN	Mild Steel	Zinc	8.10mm	0.7312kg	Yes	No	N/A	2000kg
44-4292MSZN	Mild Steel	Zinc	8.10mm	0.756kg	No	Yes	N/A	2000kg

Adjustable Toggle Latch

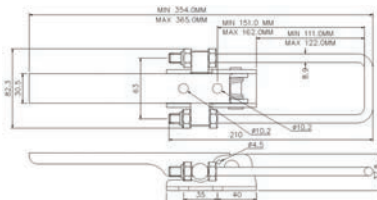

Catchplates



04-9000

SKU	MATERIAL	FINISH	HOLE Ø	WEIGHT	LOCKABLE	SAFETY	SPRING	STRENGTH
490-9000-170MSZN	Mild Steel	Zinc	N/A	0.9650kg	No	No	N/A	7000kg

ALSO AVAILABLE: OUR BEST-SELLING CATCH PLATES!



01-504MSZN



01-502MSZN



01-655CSZN/YP



03-655CSZN/YP

CATCHBOLTS

The unique PROTEX® CATCHBOLT holds firmly in three directions. The integral bolt forces a panel or door to close. The initial action of the lever will first draw two parts together. A safety catch is offered.

CATCHBOLTS

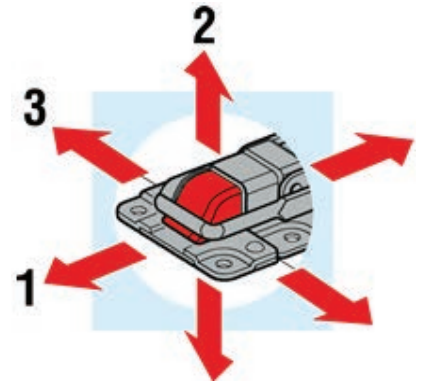
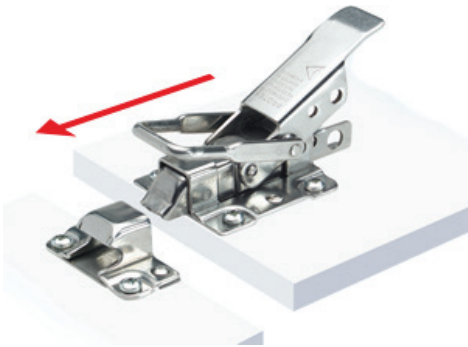

CatchBolt Padlockable

PROTEX

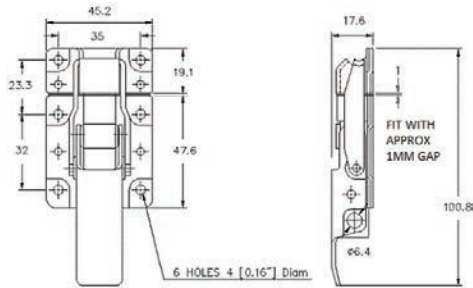

SKU	MATERIAL	FINISH	HOLE Ø	WEIGHT	LOCKABLE	SAFETY	SPRING	STRENGTH
88-1068MSZN/YP	Mild Steel	Zinc	4.10mm	0.1212kg	Yes	No	N/A	400kg

CatchBolt Safety Catch

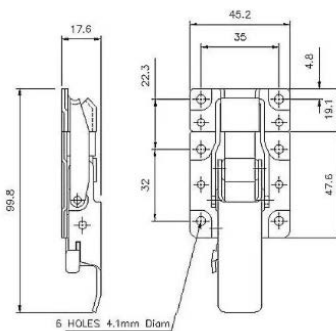

SKU	MATERIAL	FINISH	HOLE Ø	WEIGHT	LOCKABLE	SAFETY	SPRING	STRENGTH
89-1069MSZN/YP	Mild Steel	Zinc	4.10mm	0.1286kg	No	No	N/A	400kg

BANDCLAMPS

Heavy Duty Hi-Torque Rigid Claw Quick Release Bandclamp

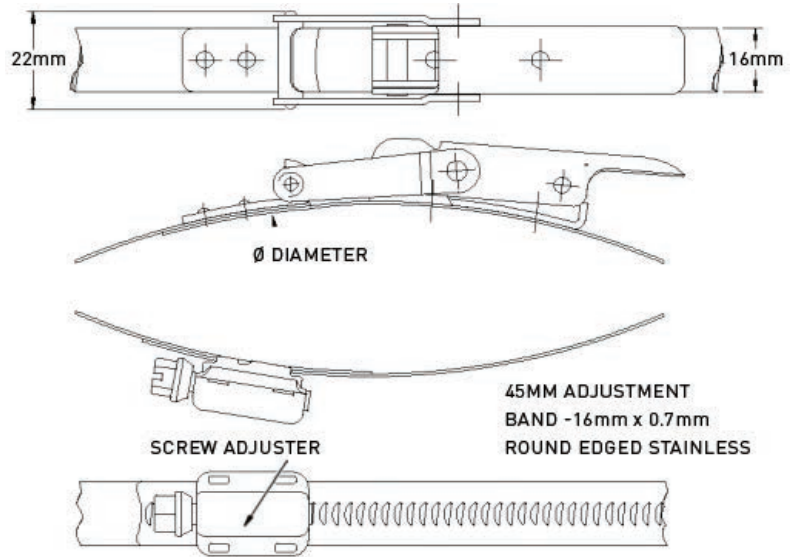

BANDCLAMPS

PROTEX

SKU	MATERIAL	FINISH	DIAMETER Ø	WEIGHT	LOCKABLE	SPRING	STRENGTH
57-HT410-455SS	Stainless	SF	410-455mm	0.2554kg	No	N/A	450kg
57-HT450-495SS	Stainless	SF	450-495mm	0.2739kg	No	N/A	450kg
57-HT490-535SS	Stainless	SF	490-535mm	0.2799kg	No	N/A	450kg
57-HT530-575SS	Stainless	SF	530-575mm	0.2884kg	No	N/A	450kg
57-HT570-615SS	Stainless	SF	570-615mm	0.2990kg	No	N/A	450kg
57-HT610-655SS	Stainless	SF	610-655mm	0.3109kg	No	N/A	450kg

Hi-Torque Rigid Claw Quick Release Bandclamp



BANDCLAMPS

PROTEX

SKU	MATERIAL	FINISH	DIAMETER Ø	WEIGHT	LOCKABLE	SPRING	STRENGTH
27-HT070-115SS	Stainless	SF	70-115mm	0.1268kg	No	N/A	200kg
27-HT090-135SS	Stainless	SF	90-135mm	0.1317kg	No	N/A	200kg
27-HT130-175SS	Stainless	SF	130-175mm	0.1446kg	No	N/A	200kg
27-HT170-215SS	Stainless	SF	170-215mm	0.1582kg	No	N/A	200kg
27-HT210-255SS	Stainless	SF	210-255mm	0.1710kg	No	N/A	200kg
27-HT250-295SS	Stainless	SF	250-295mm	0.1812kg	No	N/A	200kg
27-HT290-335SS	Stainless	SF	290-335mm	0.1962kg	No	N/A	200kg
27-HT330-375SS	Stainless	SF	330-375mm	0.2072kg	No	N/A	200kg

Hi-Grip Rigid Claw Quick Release Bandclamp



SKU	MATERIAL	FINISH	DIAMETER Ø	WEIGHT	LOCKABLE	SAFETY	SPRING	STRENGTH
27-HGR070-115SS	Stainless	SF	70-115mm	0.1302kg	No	No	N/A	150kg
27-HGR090-135SS	Stainless	SF	90-135mm	0.1340kg	No	No	N/A	150kg
27-HGR130-175SS	Stainless	SF	130-175mm	0.1491kg	No	No	N/A	150kg
27-HGR170-215SS	Stainless	SF	170-215mm	0.1579kg	No	No	N/A	150kg
27-HGR210-255SS	Stainless	SF	210-255mm	0.1742kg	No	No	N/A	150kg
27-HGR250-295SS	Stainless	SF	250-295mm	0.1848kg	No	No	N/A	150kg
27-HGR290-335SS	Stainless	SF	290-335mm	0.2014kg	No	No	N/A	150kg
27-HGR330-375SS	Stainless	SF	330-375mm	0.2102kg	No	No	N/A	150kg



SCHÜTT'S CARGO

Accessories and parts for Trailers ,Utes, Vans, & Trucks which include Twin & Four Pack Ratchet Tie Downs, Cargo Nets, Spring Bolts, Lashing Rings & Lashing Plates, Anti Luce, Trailer pins, Whale Locks, and Truck hinges.

01 Bungee Cords & Ropes **58**

02 Cargo Nets **59**

04 Ratchet Tie Downs **60**

05 UTES, Trucks, Trailers **61**

06 Locks **69**





ADJUSTABLE BUNGEE CORDS

CODE	DESCRIPTION	LENGTH
SAB4P	Adjustable bungee kit	204cm

- 4 Piece adjustable bungees
- 2 O-Ring for cross fastening



TARP CANOPY CORDS

CODE	SIZE	LENGTH
STCC4P	4mm	10cm

- 4 Pieces ball hook bungees
- Weather & abrasion resistant



BUNGEE PACK

CODE	DESCRIPTION	SIZE
SB12P	3 x 25cm mini bungee cords	46cm
	2 x 25cm tarp canopy cords	61cm
	1 x o-ring for cross fastening	76cm
		91cm

- 2 pieces x 46cm
- 2 pieces x 61cm
- 1 piece x 76cm
- 1 piece x 91cm



FLAT BUNGEE

CODE	DESCRIPTION	LENGTH
SFB35	89cm Flat Bungee Snap Hook	89cm
SFB45	114cm Flat Bungee Snap Hook	114cm

- Flat cord for added surface contact
- Injection molded grips
- Aluminium alloy hooks
- Weather and abrasion resistant



TOW ROPE

CODE	DESCRIPTION	LENGTH
STR2	2.2 Tonne tow rope	4m
STR5	5 Tonne tow rope	4m



TRUCK NETS

CODE	DESCRIPTION	SIZE
SUTNA	Adjustable Truck Net	198cm x 140cm

- 6 x adjustable bungee cords
- Strap adjusts for proper fit
- Easy to use and install



TRUCK NETS

CODE	DESCRIPTION	SIZE
STNT	Truck Net	1.5m x 2.2m

- Easy to use
- Adjustable to fit different size UTES and trailers



STORAGE NET

CODE	DESCRIPTION	LENGTH
SSNA	Adjustable storage net for SUV/cars	122 cmt to 152cm

- Works with cars, trucks, SUVs & vans for organising cargo
- Easy to install



CARGO NET

CODE	DESCRIPTION	SIZE
SCNET	Pick-up Truck Cargo Net	85cm x 115cm

- Easy to use and install

RATCHET TIE DOWNS

RATCHET TIE DOWNS

SCHUTTS CARGO

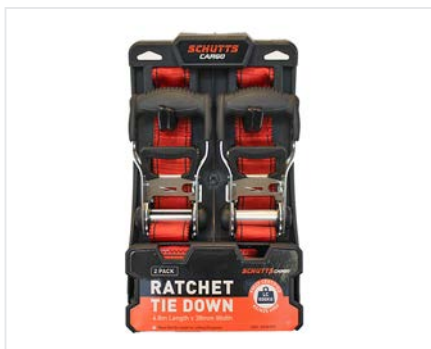

RATCHET TIE DOWN			
CODE	SIZE	LENGTH	LOAD CAPACITY
SR382PS	38mm	4.8m	500kg

● SCHUTTS CARGO convenient top quality twin & 4 pack ratchet tie downs are great value for money and quality you can trust.

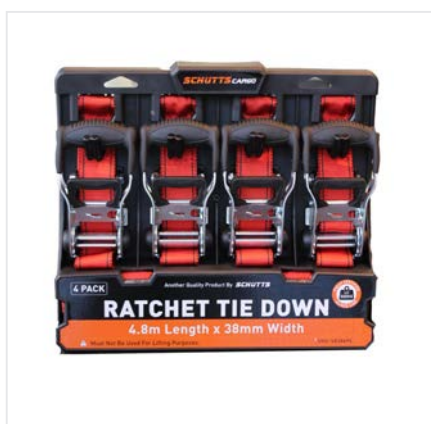

RATCHET TIE DOWN			
CODE	SIZE	LENGTH	LOAD CAPACITY
SR384PS	38mm	4.8m	500kg

- Top Quality
- SCHUTTS CARGO convenient top quality twin & 4 pack ratchet tie downs are great value for money and quality you can trust.



RATCHET TIE DOWN			
CODE	SIZE	LENGTH	LOAD CAPACITY
SR252PS	25mm	3m	227kg

● SCHUTTS CARGO convenient top quality twin & 4 pack ratchet tie downs are great value for money and quality you can trust.

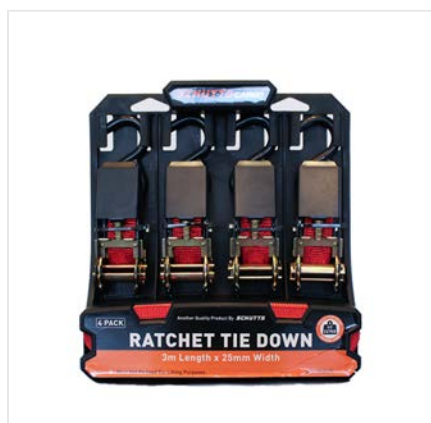

RATCHET TIE DOWN			
CODE	SIZE	LENGTH	LOAD CAPACITY
SR252PS	25mm	3m	227kg
SR254PS	25mm	3m	227kg
SR254PBS	25mm	4.6m	227kg

● SCHUTTS CARGO convenient top quality twin & 4 pack ratchet tie downs are great value for money and quality you can trust.



TOGGLE LATCHES

CODE	DESCRIPTION	SIZE
STPTLS	Toggle Latch Small	80mm
STPTLM	Toggle Latch Medium	125mm
STPTLL	Toggle Latch Large	180mm
STPTLMSS	Toggle Latch Medium Stainless Steel	125mm



DOOR TRUCK HOLDER

CODE	DESCRIPTION	SIZE
STPDH	Door Holder Set	76mm x 60mm

● Moulded black EPDM rubber. Long lasting with pressed stainless steel brackets & large style T handle for easy use.



RUBBER HATCH FASTENER

CODE	DESCRIPTION	SIZE
STPRF	Rubber fastener	125mm

● Moulded black EPDM rubber long lasting with pressed stainless steel brackets & large style T handle for easy use.



ROUND WELDING HINGE

CODE	DESCRIPTION	SIZE
STPRWH	Round Welding Hinge Axle	19mm

- 16mm Axle
- 19mm x 100mm



SPRING BOLTS		
CODE	DESCRIPTION	SIZE
STPSBS	130mm Spring Bolt	130mm
STPSBSC	136mm Spring Bolt Chunky	136mm
STP8M	200m Spring Bolt	200mm
STPS8BL	250mm Spring Bolt	250mm



LYNCH PINS		
CODE	DESCRIPTION	SIZE
STPLP5	4.5mm Lynch Pin	4.5mm
STPLP6	6mm Lynch Pin	6mm
STPLP8	8mm Lynch Pin	8mm
STPLP10	10mm Lynch Pin	10mm

● Pack of 5



ANTI LUCES		
CODE	DESCRIPTION	LENGTH
STPAL8	8mm Anti Luce Weld On	10mm
STPAL10	10mm Anti Luce Bolt On	10mm
STPAL12	12.5mm Anti Luce Weld On	12.5mm
STPAL123	12mm Anti Luce Bolt On	34mm
STPAL127	12mm Anti Luce Bolt On	75mm
STPALL	12mm Anti Luce Bolt On	75mm

● Pack of 2



BOLT AXLE		
CODE	DESCRIPTION	LENGTH
STPBA1	16mm Bolt Axle	112mm
STPBA2	19mm Bolt Axle	100mm

● Pack of 2

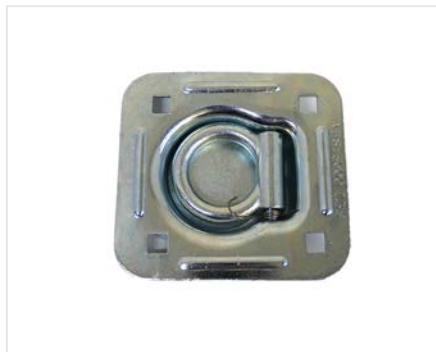

LASHING RINGS

CODE	DESCRIPTION	CAPACITY	LENGTH
STPLBS	96mm Small Lashing Ring	2000kg	102mm
STPLRL	115mm Large Lashing Ring	5000kg	124mm

- STPLBS (Pack of 2)
- STPLRL (Pack of 1)



STAINLESS STEEL LASHING RINGS

CODE	DESCRIPTION	CAPACITY	SIZE
STPLRSS	89mm Stainless Steel Lashing Ring	700kg	76mm

- Pack of 2



LASHING RING ROUND

CODE	DESCRIPTION	SIZE
STLRR	Lashing Ring Round	105mm

- Pack of 2



LASHING RING PLATES

CODE	DESCRIPTION	SIZE
STPLRP4	Lashing Ring Plate 3mm	132x142mm
STPLRP6	Lashing Ring Plate 6mm	132x142mm
STPLRP41	Lashing Ring Plate 4mm	110x115mm
STPLRP416	Lashing Ring Plate 6mm	110x115mm

- Pack of 2

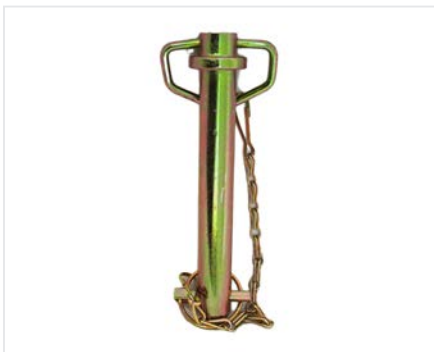

TRAILER PINS		
CODE	DESCRIPTION	LENGTH
STPTP34	3/4 inch Trailer Pin	150mm
STPTP78	7/8 inch Trailer Pin	150mm
STPTP100	1 inch Trailer Pin	150mm



TRAILER PINS		
CODE	DESCRIPTION	SIZE
STPTP	5/8 inch Trailer Pin	5/8inch



SECURING ROD			
CODE	DESCRIPTION	LENGTH	THICKNESS
STPCR	SECURING ROD	267cm	40mm Outer x 30mm Inner Shaft

- Compressed length: 227cm
- Extended length: 267cm
- Solid steel securing rod
- Lightweight and adjustable



LATCH AND BRACKET		
CODE	DESCRIPTION	SIZE
STPSBM	Steel Latch & Bracket MD	230 x 35mm
STPSLBH	Steel Latch & Bracket HD	315 x 40mm



FISH PLATE

CODE	DESCRIPTION	BOLT SIZE	PLATE SIZE
STPPF	Fish Plate	150mm x 70mm	100mm x 100mm x 5mm thickness

● Pack of 2



JOCKEY WHEELS

CODE	DESCRIPTION	LOADING CAPACITY
STPJW6	6" Jockey Wheel Swing Away	350kg



JOCKEY WHEELS

CODE	DESCRIPTION	LOADING CAPACITY
STPJW8	8" Jockey Wheel Swing Away	350kg



COUPLING BASE PLATE

CODE	DESCRIPTION	THICKNESS	SIZE
STPCBP	Coupling Base Plate Universal	5mm	150mm x 150mm



SQUARE U BOLT		
CODE	DESCRIPTION	SIZE
STPSUB1	Square U Bolt (Pack of 2)	130mm x 60mm
STPSUB2	Square U Bolt (Pack of 2)	160mm x 70mm
STPSUB3	Square U Bolt (Pack of 2)	150mm x 70mm

● Pack of 2



DOOR HINGES		
CODE	DESCRIPTION	SIZE
STPRDH1	Rear Door Hinge	347mm
STPRDH2	Rear Door Hinge	257mm



DOOR HINGES		
CODE	DESCRIPTION	SIZE
STPHB	Door Hinge Body	325mm



DOOR HINGES		
CODE	DESCRIPTION	SIZE
STPTH1	Truck Steel Hinge	290mm



TRUCK DOOR LOCKING KIT		
CODE	DESCRIPTION	SIZE
STPTDLK1	34mm Truck Door Locking Kit	34mm



TRUCK DOOR LOCKING KIT		
CODE	DESCRIPTION	SIZE
STPTDLK2	27mm Truck Door Locking Kit	27mm



TRUCK DOOR LOCKING KIT		
CODE	DESCRIPTION	SIZE
STPTDLK3	34mm Truck Door Locking Kit	34mm



FOLDING LADDER		
CODE	DESCRIPTION	SIZE
STPFL3	3 Step Folding Ladder	L 720 x W 360 mm

- Ideal for trucks caravans or UTES + trailers



TRUCK LOCKING HANDLE

CODE	DESCRIPTION	LENGTH
STPTLH	Truck Locking Handle Zinc Plated	350mm



TRUCK SEAL

CODE	DESCRIPTION	LENGTH
STPTS	Truck Seal PVC	3m



RATCHET WINDERS

CODE	DESCRIPTION	LENGTH	WEIGHT
STPRWR	Ratchet Winders Right	L 330 x Body W 60mm	165kg
STPRWL	Ratchet Winders Left	L 330 x Body W 60mm	165kg
STPRWRL	Ratchet Winders Right & Left	L 330 x Body W 60mm	330kg



TRUCK STRAP WINCH

CODE	DESCRIPTION	SIZE	LOADING CAPACITY
STPSW	Truck Strap Winch	170 x 60mm	5000kg

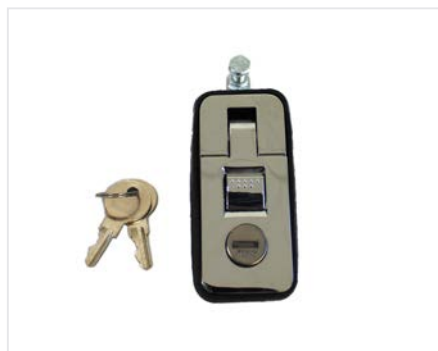

CHROME LOCK WITH KEY

CODE	DESCRIPTION	LENGTH
STPCLS	35mm Small Chrome Lock with Key	85mm
STPCML	50mm Medium Chrome Lock with Key	104mm



BLACK LOCK WITH KEY

CODE	DESCRIPTION	LENGTH
STPBLS	35mm Small Black Lock with key	80mm
STPBML	50mm Medium Black Lock with Key	104mm



TRUCK DOOR PADDLE LOCK

CODE	DESCRIPTION	LENGTH
STPTDPL	Truck Door Paddle Lock	250mm



PADDLE LOCK

CODE	DESCRIPTION	SIZE
STPPLSS	Stainless Steel Drop T Lock	108mm x 140mm



DROP T WHALE TAIL

CODE	DESCRIPTION	SIZE
DROPTBC	Drop T Whale Tail Chrome/ Black	L 124 x W122
DROPT ECB	Electric Drop T Whale Tail Chrome Black	L 124 x W 122



DROP T LOCK

CODE	DESCRIPTION	SIZE
STPPLTSS	T Type Stainless Steel Drop T Lock	121mm x 125mm

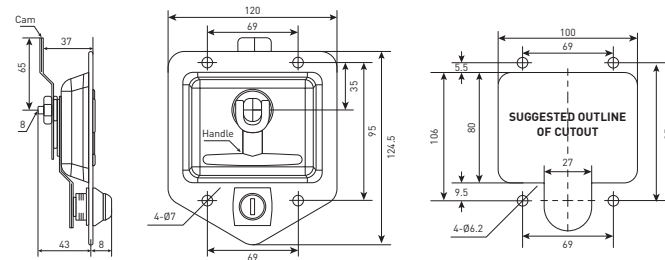

DROP T LOCK

CODE	DESCRIPTION	SIZE
CS2000SS	Stainless Steel Drop T Lock	108mm x 140mm
CS2000STUD	Stainless Steel Drop T Lock with Threaded Studs	121mm x 125mm

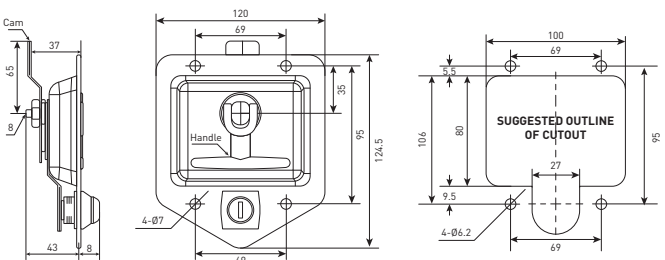



SCHÜTTTS

HARDWARE

Features a large range of Non-Rated Bow & Dee Shackles as well as Stainless Steel Bow & Dee Shackles, Plus Non-Rated & Stainless-Steel Hook & Eye, Eye to Eye Turnbuckles. Also available Snap hooks, Quick links, Cam Locks & Lock Kits, Continuous hinge both in Galvanized & Stainless Steel, and A range of medium & heavy duty Draw slides.

01 Turnbuckles	72
02 Bow & Dee Shackles	73
03 Snap Hooks, Quick Links, Swivels	74
04 Handles	75
05 Handles & Locks	76
06 Rubbers	88
07 Hinges	90
08 Drawer Slides	92



STAINLESS STEEL TURNBUCKLES EYE TO EYE GRADE 304

CODE	NOM. SIZE
STEE5SS	5mm
STEE6SS	6mm
STEE8SS	8mm
STEE10SS	10mm
STEE12SS	12mm



STAINLESS STEEL TURNBUCKLES HOOK TO EYE GRADE 304

CODE	NOM. SIZE
STHE5SS	5mm
STHE6SS	6mm
STHE8SS	8mm
STHE10SS	10mm
STHE12SS	12mm



COMMERCIAL TURNBUCKLES EYE TO EYE (NON RATED)

CODE	NOM. SIZE
SCTEE6	6mm
SCTEE8	8mm
SCTEE10	10mm
SCTEE12	12mm
SCTEE16	16mm
SCTEE20	20mm

* Non metric thread



COMMERCIAL TURNBUCKLES HOOK TO EYE (NON RATED)

CODE	NOM. SIZE
SCTHE6	6mm
SCTHE8	8mm
SCTHE10	10mm
SCTHE12	12mm
SCTHE16	16mm
SCTHE20	20mm

* Non metric thread



STAINLESS STEEL DEE SHACKLES GRADE 304

CODE	SIZE
SDS5SS	5mm
SDS6SS	6mm
SDS8SS	8mm
SDS10SS	10mm
SDS12SS	12mm
SDS16SS	16mm
SDS20SS	20mm



STAINLESS STEEL BOW SHACKLES GRADE 304

CODE	SIZE
SBS5SS	5mm
SBS6SS	6mm
SBS8SS	8mm
SBS10SS	10mm
SBS12SS	12mm
SBS16SS	16mm
SBS20SS	20mm



COMMERCIAL DEE SHACKLES (NON RATED)

CODE	SIZE
SCDS5	5mm
SCDS6	6mm
SCDS8	8mm
SCDS10	10mm
SCDS12	12mm
SCDS16	16mm
SCDS20	20mm
SCDS25	25mm



COMMERCIAL BOW SHACKLES (NON RATED)

CODE	SIZE
SCBS5	5mm
SCBS6	6mm
SCBS8	8mm
SCBS10	10mm
SCBS12	12mm
SCBS16	16mm
SCBS20	20mm
SCBS25	25mm



STAINLESS STEEL SNAP HOOK GRADE 304

CODE	NOM. SIZE
SH5SS	5mm
SH6SS	6mm
SH8SS	8mm
SH10SS	10mm



ZINC SNAP HOOK

CODE	SIZE
SH5	5mm
SH6	6mm
SH8	8mm
SH10	10mm
SH12	12mm



ZINC QUICK LINK

CODE	SIZE
SQL5	5mm
SQL6	6mm
SQL8	8mm
SQL10	10mm
SQL12	12mm



COMMERCIAL SWIVEL (NON RATED)

CODE	SIZE
SCG414	1/4
SCG416	5/16
SCG438	3/8
SCG412	1/2
SCG458	5/8
SCG434	3/4
SCG478	7/8
SCG411	1"

Spring Loaded Handle

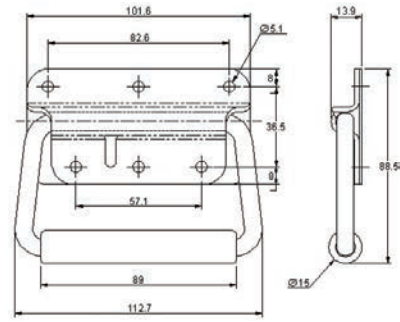

SKU	MATERIAL	FINISH	HOLE Ø	WEIGHT	LOCKABLE	SAFETY	SPRING	STRENGTH
95-637MSZN	Mild Steel	Zinc	5.10mm	0.2596kg	No	No	N/A	100kg
95-637SS	Stainless	SF	5.10mm	0.2547kg	No	No	N/A	150kg
95-637MSBL	Mild Steel	Black	5.10mm	0.2598kg	No	No	N/A	100kg

Spring Loaded Handle

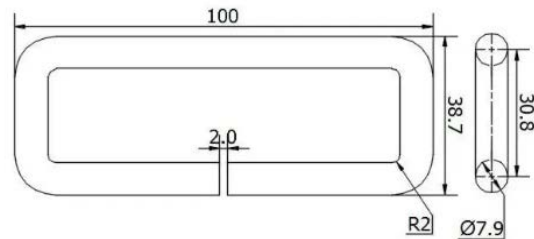

SKU	MATERIAL	FINISH	HOLE Ø	WEIGHT	LOCKABLE	SAFETY	SPRING	STRENGTH
94-677MSZN	Mild Steel	Zinc	N/A	0.0881kg	No	No	N/A	100kg

Recessed Spring Loaded Handle

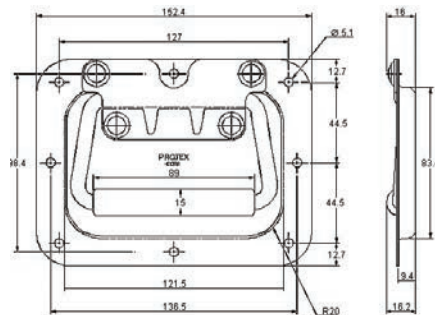

SKU	MATERIAL	FINISH	HOLE Ø	WEIGHT	LOCKABLE	SAFETY	SPRING	STRENGTH
97-596MSZN	Mild Steel	Zinc	5.10mm	0.3509kg	No	No	N/A	100kg
97-596SS	Stainless	SF	5.10mm	0.3561kg	No	No	N/A	150kg

HADNLES

SCHUTTS HARDWARE

Small T Shape Handle - Rear Fix



DIMENSIONS

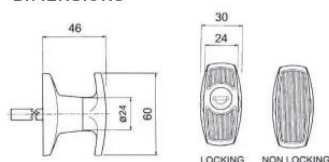

FIXING HOLE DETAILS

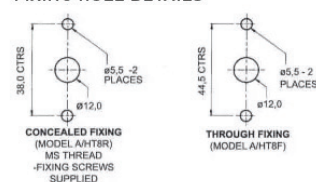

NOTE: Non-Locking and Cam Options are Available

SKU	MATERIAL FINISH	LOCK	FIXING	LENGTH	HEIGHT	WIDTH
SMLTRF001	Chrome	24mm	38mm	46mm	30mm	60mm
SMLTRF003	Chrome	24mm	38mm	46mm	30mm	60mm
SMLTRF268	Chrome	24mm	38mm	46mm	30mm	60mm

Large T Shape Handle - Rear Fix



DIMENSIONS

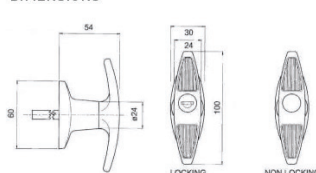

FIXING HOLE DETAILS

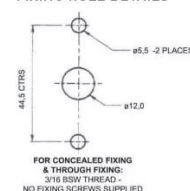

NOTE: Non-Locking and Cam Options are Available

SKU	MATERIAL FINISH	LOCK	FIXING	LENGTH	HEIGHT	WIDTH
LGETRFNL	Chrome	Non Locking	44.5mm	54mm	30mm	100mm
LGETRF001	Chrome	24mm	44.5mm	54mm	30mm	100mm
LGETRF268	Chrome	24mm	44.5mm	64mm	30mm	100mm

Large T Shape Handle - 1/4 Turn

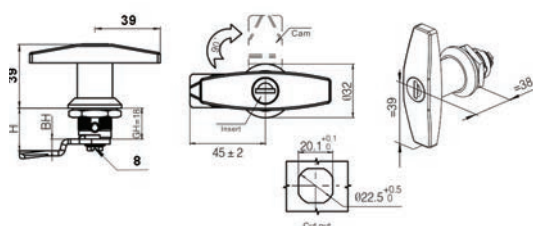

NOTE: CL001 & 92268 Key Types and Cam Options are Available

SKU	MATERIAL	FINISH	LOCK	LENGTH	HEIGHT	WIDTH
CHROME14TURNCL001	Brass	Chrome	32mm	39mm	32mm	90mm
CHROME14TURN92268	Brass	Chrome	32mm	39mm	32mm	90mm

Key Locking Lever Handle

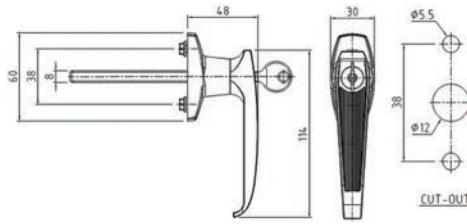

NOTE: Types, Non-Locking and Cam Options are Available

SKU	MATERIAL	FINISH	LOCK	FIXING	LENGTH	HEIGHT	WIDTH
LEVRRFNL	Stainless	SF	Non-Locking	38mm	48mm	114mm	30mm
LEVRRF001	Stainless	SF	12mm	38mm	48mm	114mm	30mm
LEVRRF268	Stainless	SF	12mm	38mm	48mm	114mm	30mm

Padlockable Lever Handle with HASP Bracket

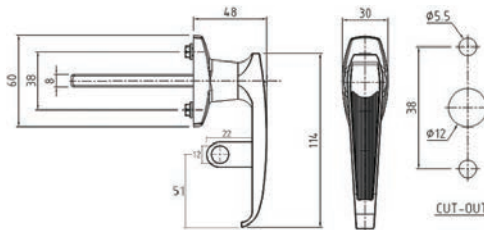

NOTE: Clockwise or Anti-clockwise unlockable are Available

SKU	MATERIAL	FINISH	LOCK	FIXING	LENGTH	HEIGHT	WIDTH
PADLEVACW	Stainless	SF	12mm	38mm	48mm	115mm	30mm
PADLEVCW	Stainless	SF	12mm	38mm	48mm	115mm	30mm

Die Cast Cam to Suit T Handles, Lever Handles

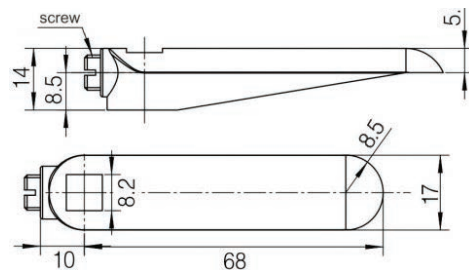

SKU	MATERIAL	FINISH	SPINDLE SIZE	LENGTH	HEIGHT	WIDTH
CAMDIECAST	Mild Steel	Zinc	8mm	78mm	14mm	17mm

Padlockable Swing Handle

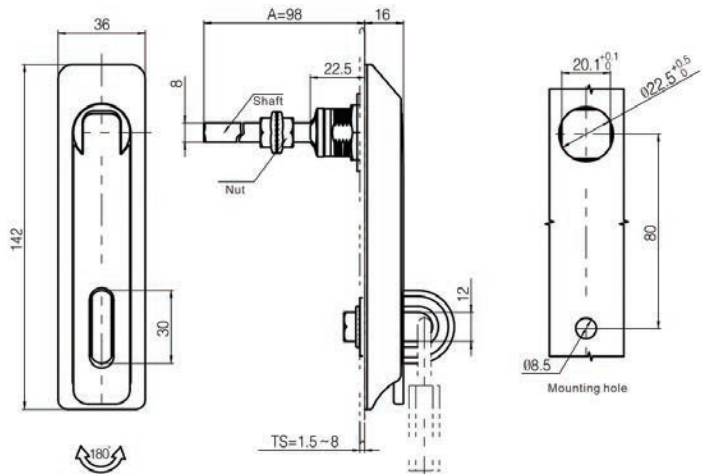

NOTE: Cam Options are Available

SKU	MATERIAL	FINISH	LOCK	FIXING	LENGTH	HEIGHT	WIDTH
11075CC0460	Brass	Chrome	22.5mm	80mm	142mm	15mm	36mm
11075SS0231660	Stainless	SF	22.5mm	80mm	142mm	15mm	36mm

Key Locking Swing Handle

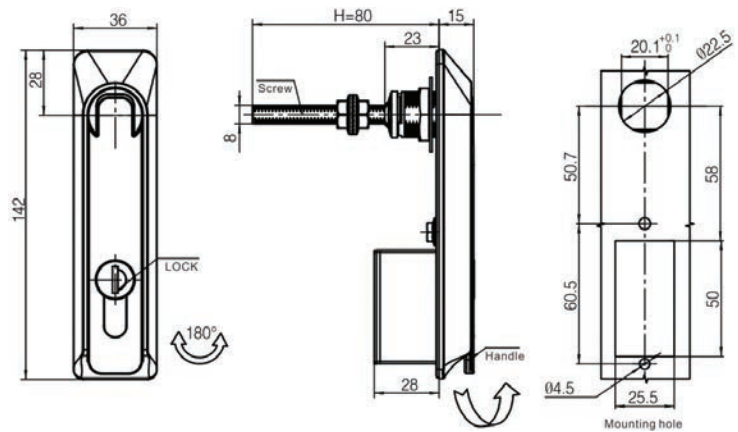
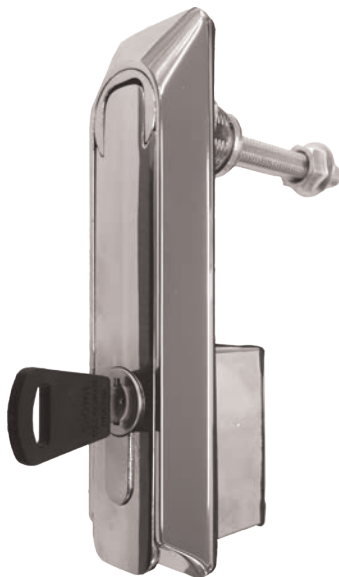

NOTE: Cam Options are Available

SKU	MATERIAL	FINISH	LOCK	FIXING	LENGTH	HEIGHT	WIDTH
11075CC0301	Brass	Chrome	22.5mm	60.5mm	142mm	15mm	36mm
MILCENIUMSS	Stainless	SF	22.5mm	60.5mm	142mm	15mm	36mm

Chest Handle

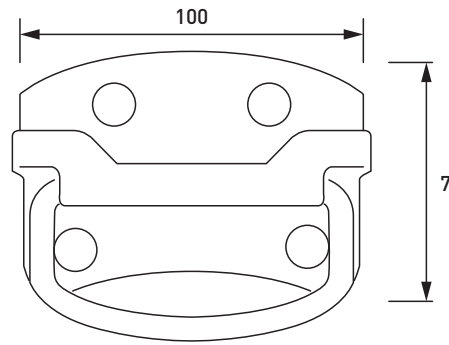
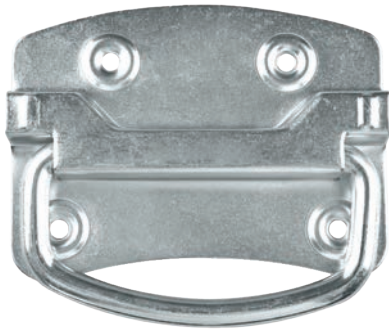

SKU	MATERIAL	FINISH	LENGTH	WIDTH
11605	Mild Steel	Zinc	100mm	75mm

D Shape Pull Handle

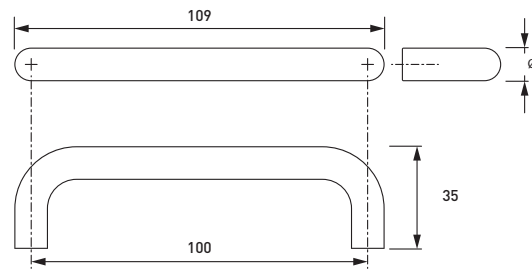

NOTE: 316 Grade Stainless Steel is Available on Enquire

SKU	MATERIAL	FINISH	DIAMETER Ø	FIXING	LENGTH	HEIGHT
DPULL100MM30455	304 Stainless	SF	8mm	100mm	109mm	35mm
DPULL100MM	Brass	Chrome	8mm	100mm	109mm	35mm

D Flat Diecast Handle

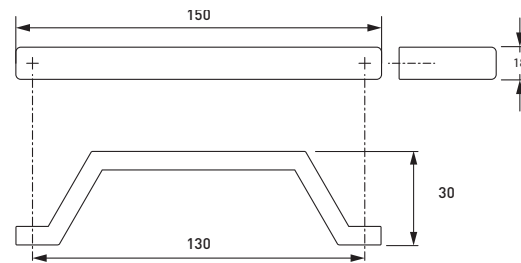

SKU	MATERIAL	FINISH	FIXING	LENGTH	HEIGHT	WIDTH
FLATDHANDLE	Brass	Chrome	130mm	150mm	30mm	18mm

T HANDLE DOOR LOCK



SCHÜTTTS CARGO

SKU	DESCRIPTION	LENGTH	WIDTH
STPLHL	T handle door lock with diecast cam & key	130mm	100mm

L HANDLE DOOR LOCK



SCHÜTTTS CARGO

SKU	DESCRIPTION	LENGTH	WIDTH
STPLHL	L handle door lock with diecast cam & key	130mm	110mm

TRUCK BOX CHEST HANDLE



SCHÜTTTS CARGO

SKU	DESCRIPTION	FINISH	LENGTH	WIDTH
STPTBH	Truck Box Chest Steel Handle	Zinc	86mm	45mm
STPTBSH	Truck Box Chest Stainless Steel	Stainless	86mm	45mm

HANDLES & LOCKS

SCHÜTTTS HARDWARE

PLASTIC HANDLE



SCHUTTS CARGO

SKU	DESCRIPTION	LENGTH
STPPH	Plastic Handles Black Textured (Pack of 2)	187mm

D FLAT DIECAST HANDLE



SCHUTTS CARGO

SKU	MATERIAL	FINISH	FIXING	LENGTH	HEIGHT	WIDTH
FLATDHANDLE	Brass	Chrome	130mm	150mm	30mm	18mm

STEEL HANDLE



SCHUTTS CARGO

SKU	DESCRIPTION	LENGTH
STPSH	Steel Handle Zinc Coated (Pack of 2)	128mm

Handle

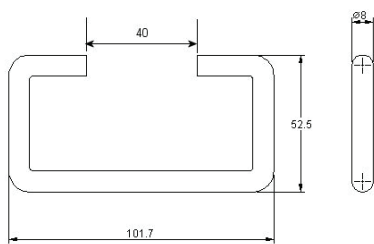

Baseplates



94-120BMSZN

94-120SS

SKU	MATERIAL	FINISH	HOLE Ø	WEIGHT	LOCKABLE	SAFETY	SPRING	STRENGTH
94-120AMSZN	Mild Steel	Zinc	N/A	0.0850kg	No	No	N/A	100kg
94-120ASS	Stainless	SF	N/A	0.0855kg	No	No	N/A	150kg

Handle

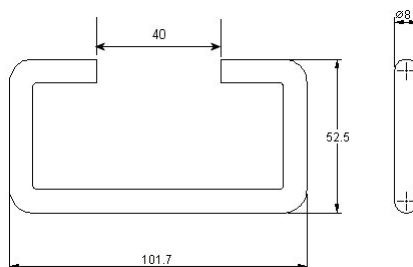

Baseplates

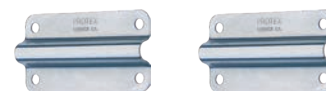

93-1044BMSZN

93-1044SS

SKU	MATERIAL	FINISH	HOLE Ø	WEIGHT	LOCKABLE	SAFETY	SPRING	STRENGTH
93-1044AMSZN	Mild Steel	PVC	N/A	0.0850kg	No	No	N/A	100kg
93-1044ASS	Stainless	PVC	N/A	0.0855kg	No	No	N/A	150kg

D Shape Pull Handle

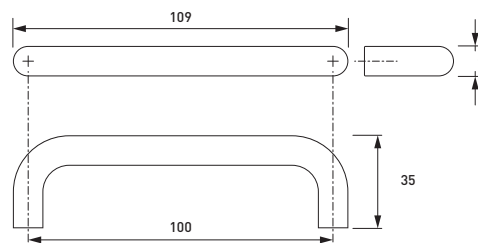

NOTE: 316 Grade Stainless Steel is Available on Enquire

SKU	MATERIAL	FINISH	DIAMETER Ø	FIXING	LENGTH	HEIGHT
DPULL100MM30455	304 Stainless	SF	8mm	100mm	109mm	35mm
DPULL100MM	Brass	Chrome	8mm	100mm	109mm	35mm

CAM LOCKS

A small scale lock that is commonly used for petty cash lock boxes and letter boxes, these are also referred to as coin locks.

Round Face Cam Lock



16MM ROUND FACE Technical Information

SKU	16MMRF001
MATERIAL	Steel
WIDTH	22.5mm
LENGTH	22.5mm
THREAD L	16mm

19MM ROUND FACE Technical Information

SKU	19MMRF001
MATERIAL	Steel
WIDTH	22.2mm
LENGTH	22.2mm
THREAD L	19mm

HANDLES & LOCKS

SCHUTTS HARDWARE

Locking Quarter TurnLock

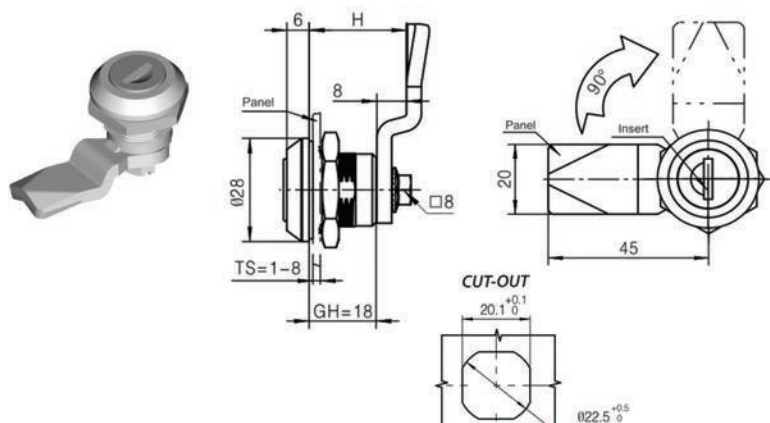

SKU	MATERIAL	FINISH
1/4TURNCL001	Steel	Chrome

QUARTER TURN LOCKS

Please follow the following steps:

1. CHOOSE STYLE

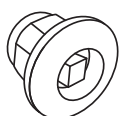

SL7S
7mm Square

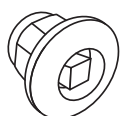

SL8S *
8mm Square

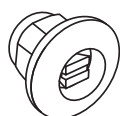

SL8SS *
5mm Square
2mm Slot



SL8ES
2mm Driver Slot



SL8TS *
8mm Triangle

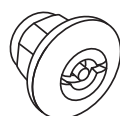

SL8D3
3mm Pin

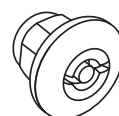

SL8D5
5mm Pin

SKU	LOCK FACE	MATERIAL	H=	OFFSET
SL7S	7mm Square	Steel	25mm	7mm
SL8S	8mm Square	Steel	40mm	22mm
SL8TS	Triangle	Steel	25mm	7mm
SL8ES	Driver Slot	Steel		
SL8D3	3mm Pin	Steel		
SL8D5	5mm Pin	Steel		

SKU	LOCK FACE	MATERIAL	H=	OFFSET
SL8SUSS/	8mm Square	Stainless	25mm	7mm
SL8SUSS/	8mm Square	Stainless	40mm	22mm
SL8TSS/	Triangle	Stainless	25mm	7mm
SL8SSS/	Square with	Stainless	25mm	7mm
SL8SSS/	Square with	Stainless	32mm	14mm
SL8SSS/	Square with	Stainless	40mm	22mm

2. CHOOSE CAM



CAM OPTIONS

SKU	H=	CAM OFFSET
SC20	20mm	2mm
SC25	25mm	7mm
SC28	28mm	10mm
SC32	32mm	14mm
SC40	40mm	22mm
SC44	44mm	26mm
SC57	57mm	39mm

2. CHOOSE KEY



KEY OPTIONS

SKU	TO SUIT LOCK
SL7SK	SL7S
SL8TK	SL8T
SL8SK	SL8S
	SL8SS
SL8DK	SL8D3
	SL8D5

NOTE: * Stainless Steel is Available on Request.

Non-Locking Quarter Turn Lock with Wing



SKU	MATERIAL	FINISH
10000149	Steel	Chrome

Locking Quarter Turn Lock with Wing

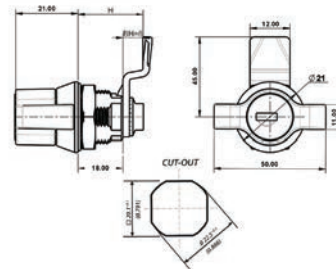

NOTE: CL001 Key Types and Cam Options are Available

SKU	MATERIAL	FINISH
QTW-001-26	Steel	Black
QTW-001-24	Steel	Chrome

Padlockable Quarter Turn Lock with Wing

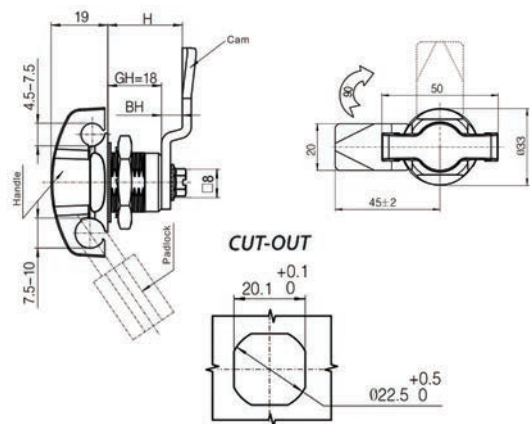

SKU	MATERIAL	FINISH
1/4TRUNDOUBLEPADLOCK	Steel	Chrome

3 Point Riveted Rods

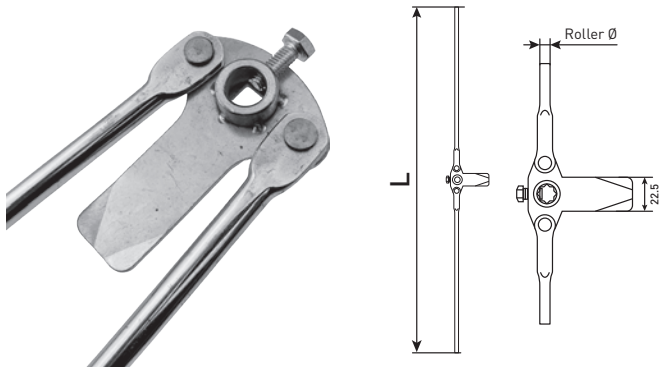

Riveted Rods 9mmØ

This rod lock is a 3 point locking system, and can be fitted with a handle using the 9mm hole. 3 point rod set for use in doors, tool boxes and ute canopies.

SKU	ROLLER DIAMETER Ø	LENGTH
ROD-1200	8mm	1200mm
ROD-1800	8mm	1800mm
ROD-2400	9mm	2400mm

3 Point Roller Rods

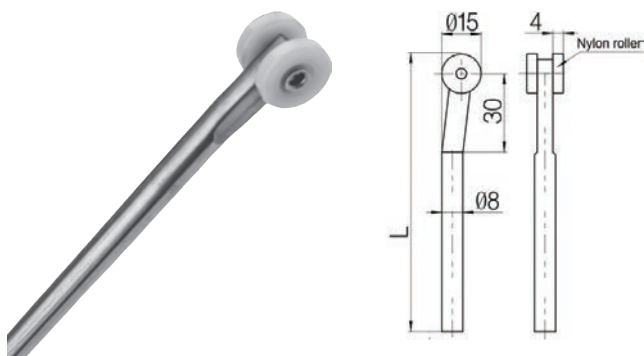

Roller Rods 8mmØ

The rollers on this rod allow for smooth movement when opening and closing a lock. This rod is to be used in conjunction with a handle, drop T lock, or other accessory.

SKU	ROLLER DIAMETER Ø	WHEEL DIAMETER Ø	LENGTH
TLR12	8mm	15mm	1200mm
TLR18	8mm	15mm	1800mm
TLR24	9mm	15mm	2400mm

Roller Rod Cam

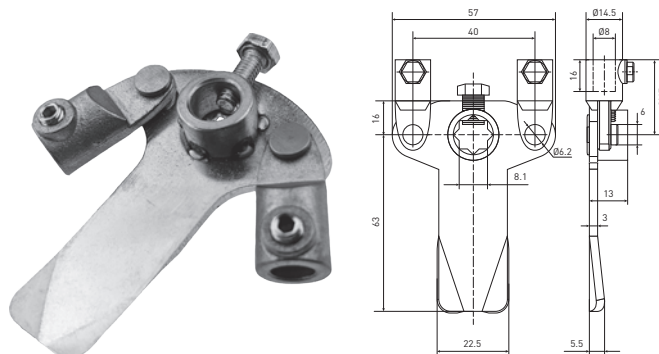

Roller Rod Cam

Cam to suit Roller Rods. The 3 way cam is designed for use with a handle, and plain ended rods. Commonly used in applications on motor homes, utes, tray backs, camper trailers and tool boxes. Also used for mining, vehicle body manufacture, transport, marine and defence vehicles.

SKU	LENGTH	WIDTH	HEIGHT
S3BCAM	90mm	45mm (CTC)	20mm



1/4 TURN LOCK KITS 2 ROLLER RODS

DESCRIPTION	NOM. SIZE	INFORMATION
318mm size lock kit: keyed 92268 or CL001	318mm	LMEC92268LOCKKIT LMECC001LOCKKIT
442mm size lock kit: keyed 92268 or CL001	442mm	LMED92268LOCKKIT LMEDCL001LOCKKIT
542mm size lock kit: keyed 92268 or CL001	542mm	LMEE92268LOCKKIT LMEEC001LOCKKIT
692mm size lock kit: keyed 92268 or CL001	692mm	LMEF92268LOCKKIT LMEFCL001LOCKKIT
842mm size lock kit: keyed 92268 or CL001	842mm	LMEG92268LOCKKIT LMEGCL001LOCKKIT
992mm size lock kit: keyed 92268 or CL001	992mm	LMEH92268LOCKKIT LMEHCL001LOCKKIT
1/4 turn lock with 3 point cam and 2 roller rods: keyed to 92268 or CL001	3 point cam and 2 roller rods	CHOOSE SIZE AND KEY



1/4 TURN LOCK KITS 2 RODS

DESCRIPTION	NOM. SIZE	LENGTH
950mm 3 point locking rods with large t shaped handle: keyed 92268 or CL001	950mm	WPD92268LOCKKIT WPDCL001LOCKKIT
1150mm 3 point locking rods with large t shaped handle: keyed 92268 or CL001	1150mm	WPE92268LOCKKIT WPECL001LOCKKIT
1450mm 3 point locking rods with large t shaped handle: keyed 92268 or CL001	1450mm	WPF92268LOCKKIT WPFCL001LOCKKIT
1750mm 3 point locking rods with large t shaped handle: keyed 92268 or CL001	1750mm	WPG92268LOCKKIT WPGCL001LOCKKIT
2050mm 3 point locking rods with large t shaped handle: keyed 92268 or CL001	2050mm	WPH92268LOCKKIT WPHCL001LOCKKIT
1/4 turn lock with 3 point cam and 2 roller rods: keyed to 92268 or CL001	3 point cam and 2 roller rods	CHOOSE SIZE AND KEY

Self Adhesive Rubber



Self Adhesive rubber is made to last and is well suited for outdoor use or in areas exposed to harsh weather conditions (Black Rubber Only). This versatile product is a handy tool perfect for use in most construction or automotive industries.

NOTE: Available in Closed Cell (Black) or Open Cell (Grey).

SKU	WIDTH	LENGTH	
SA-RUB 0903	9mm	3mm	25 Meter
SA-RUB 1203	12mm	3mm	25 Meter
SA-RUB 1206	12mm	6mm	12.5 Meter
SA-RUB 2003	20m	3mm	25 Meter
SA-RUB 2006	20m	6mm	12.5 Meter
SA-RUB 2403	24mm	3mm	25 Meter
SA-RUB 2406	24mm	6mm	12.5 Meter
SA-RUB 2409.5	24mm	9.5mm	8 Meter

Pinchweld Rubber

Pinchweld Rubber are multipurpose rubber fittings used for a range of applications. They can be used as protective covers over sharp or exposed metal, glass or fibre glass edges.

By gripping the edge of the panel, they can create a dust-proof and waterproof seal around openings in doors, windows, boots, bonnets, boxes and more. They can also be used to help with soft closing and to reduce rattling between panels.

Our quality pinchweld rubber is on side black 50 metre roll and sold per metre, minimum order quantity is 5 meters.

NOTE: Other Sizes Available On Request.



Pinchweld Door Seal Cage with Top Bulb

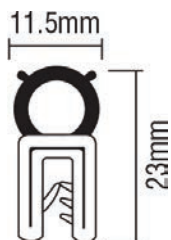

SKU	GRIP RANGE	ROLL SIZE	MINI ORDER
60-051	0.5 - 4.0mm	50m	5m

Pinchweld Door Seal with Side Bulb

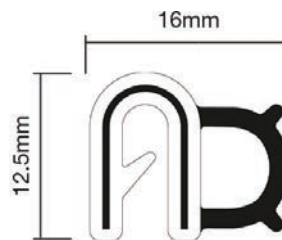

SKU	GRIP RANGE	ROLL SIZE	MINI ORDER
60-052	1.0 - 2.5mm	50m	5m

Pinchweld Door Seal with Side Bulb

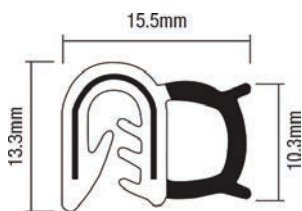

SKU	GRIP RANGE	ROLL SIZE	MINI ORDER
60-053	0.5 - 4.0mm	50m	5m

Pinchweld Door Seal Cage with Top Bulb

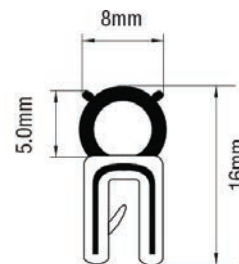

SKU	GRIP RANGE	ROLL SIZE	MINI ORDER
60-057	1.0 - 2.0mm	50m	5m

Pinchweld Door Seal with Side Bulb

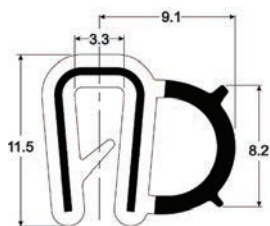

SKU	GRIP RANGE	ROLL SIZE	MINI ORDER
60-058	1.0 - 2.0mm	50m	5m

Pinchweld Black Rubber



SKU	GRIP RANGE	ROLL SIZE	MINI ORDER
66-035	0.5 - 2.0mm	50m	5m

Pinchweld Door Seal with Top Bulb

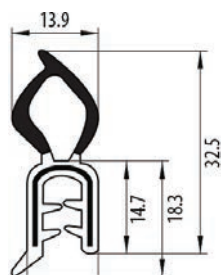

SKU	GRIP RANGE	ROLL SIZE	MINI ORDER
TB-002	0.8 - 4.0mm	50m	5m

Pinchweld Door Seal with Top Bulb

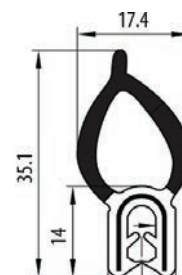

SKU	GRIP RANGE	ROLL SIZE	MINI ORDER
TB-003	1.0 - 2.5mm	50m	5m

Pinchweld Door Seal with Side Bulb

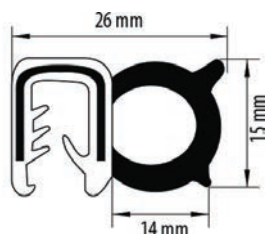

SKU	GRIP RANGE	ROLL SIZE	MINI ORDER
SB-001	1.5 - 5.6mm	50m	5m

Pinchweld Door Seal with Side Bulb

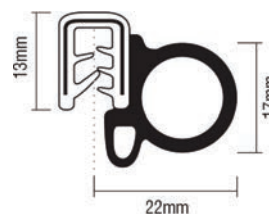

SKU	GRIP RANGE	ROLL SIZE	MINI ORDER
SB-002	0.8 - 3.0mm	50m	5m

Pinchweld Door Seal with Side Bulb

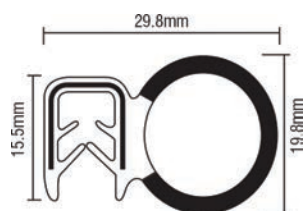

SKU	GRIP RANGE	ROLL SIZE	MINI ORDER
SB-003	0.8 - 2.5mm	50m	5m

Pinchweld Door Seal with Side Bulb

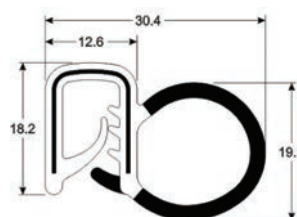

SKU	GRIP RANGE	ROLL SIZE	MINI ORDER
SB-004	2.0 - 5.0mm	50m	5m

RUBBERS

SCHUTTS HARDWARE

Piano Hinges

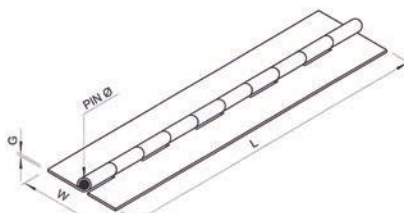

Piano Hinge: Galvanized

SKU	MATERIAL	OPEN WIDTH (W)	THICKNESS (G)	LENGTH (L)	PIN DIAMETER (Ø)
05275GAL-BR	Galvanised With A Brass Pin	25mm	1.2mm	1800mm	3.0mm
05167GAL-BR	Galvanised With A Brass Pin	32mm	1.2mm	1800mm	3.0mm
05276GAL-BR	Galvanised With A Brass Pin	38mm	1.2mm	1800mm	3.2mm
05234GAL-BR	Galvanised With A Brass Pin	50mm	1.2mm	1800mm	3.2mm
05089GAL-BR	Galvanised With A Brass Pin	57mm	1.6mm	2160mm	4.5mm
05226GAL-BR	Galvanised With A Brass Pin	63mm	1.6mm	2160mm	4.5mm
05237GAL-BR	Galvanised With A Brass Pin	76mm	1.6mm	2160mm	4.5mm
05004GAL-BR	Galvanised With A Brass Pin	127mm	2.0mm	2100mm	4.5mm

Piano Hinge: Stainless Steel 304

SKU	MATERIAL	OPEN WIDTH (W)	THICKNESS (G)	LENGTH (L)	PIN DIAMETER (Ø)
05096ASS	Stainless Steel	25mm	1.2mm	1800mm	2.5mm
05165ASS	Stainless Steel	32mm	1.2mm	1800mm	3.2mm
05165ASSB	Stainless Steel (Matte)	32mm	1.2mm	1800mm	3.2mm
05200ASS	Stainless Steel	38mm	1.2mm	1800mm	3.2mm
05149ASS	Stainless Steel	38mm	1.6mm	1840mm	3.2mm
05141ASSB	Stainless Steel (Matte)	50mm	1.2mm	1800mm	3.2mm
05141ASS	Stainless Steel	50mm	1.2mm	1800mm	3.2mm
05077ASS	Stainless Steel	50mm	1.6mm	1840mm	4.5mm
05085ASS	Stainless Steel	57mm	1.6mm	2160mm	4.5mm
05252ASSB	Stainless Steel (Matte)	76mm	1.6mm	2160mm	4.5mm
05252ASS	Stainless Steel	76mm	1.6mm	2160mm	4.5mm
05041ASS	Stainless Steel	127mm	2.00mm	2100mm	4.5mm

Piano Hinge: Mild Steel

SKU	MATERIAL	OPEN WIDTH (W)	THICKNESS (G)	LENGTH (L)	PIN DIAMETER (Ø)
05163AMS	Mild Steel	32mm	1.2mm	1828mm	3.2mm
05003AMS	Mild Steel	38mm	1.2mm	1800mm	3.2mm
05148AMS	Mild Steel	38mm	1.5mm	1828mm	4.5mm
05002AMS	Mild Steel	50mm	1.2mm	1828mm	3.2mm
05074AMS	Mild Steel	50mm	1.6mm	1830mm	4.5mm
05015AMS	Mild Steel	63mm	1.5mm	1828mm	4.5mm
05086AMS	Mild Steel	57mm	1.6mm	2160mm	4.5mm
05018AMS	Mild Steel	76mm	1.6mm	2438mm	4.5mm

Small Block Hinge

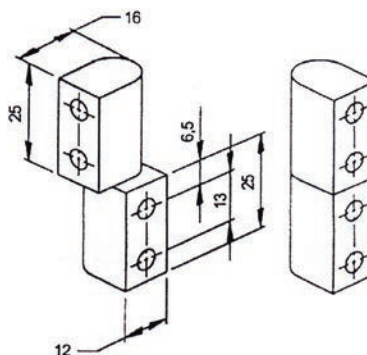

SKU	MATERIAL	FINISHED	WIDTH	LENGTH	PIN DIAMETER (Ø)	SCREWS
16MMSMLBLOCKHINGE	Brass	Chrome	16mm	50mm	6mm Stainless Steel	M6 x 8mm

Standard Block Hinge

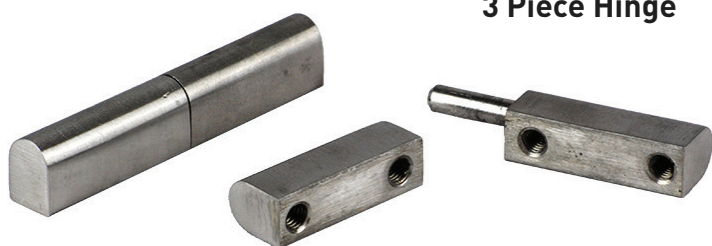

3 Piece Hinge

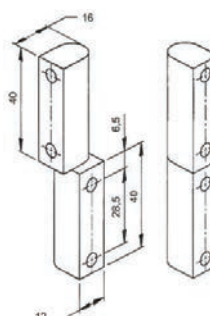

SKU	MATERIAL	FINISHED	WIDTH	LENGTH	PIN DIAMETER (Ø)	SCREWS
16MMSTDBLOCKHINGE	Brass	Chrome	16mm	80mm	6mm Stainless Steel	M6 x 8mm
ID81SS	Stainless	Natural	16mm	80mm	6mm Stainless Steel	M6 x 8mm
AD03	Metal	Black	16mm	19mm	Dome Head	Hinge
AD04	Metal	Black	19mm	16mm	Dome Head	Hinge

Stepped Pintle Hinge

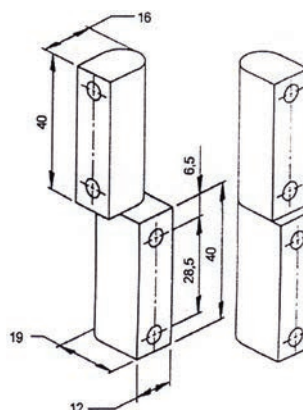
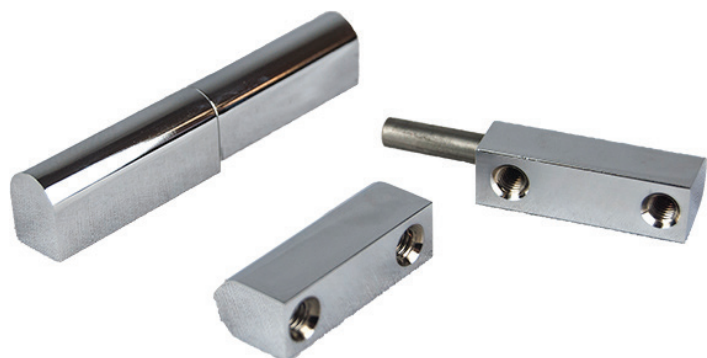

SKU	MATERIAL	FINISHED	WIDTH	LENGTH	STEPPED PIN DIAMETER (Ø)	SCREWS
AD831	Brass	Chrome	16mm	80mm	3mm 6mm Stainless Steel	M6 x 8mm

HINGES

SCHUTTS HARDWARE

Drawerslides
Medium Duty Drawerslides



HIGH QUALITY DRAWER RUNNERS FIT FOR ALL PURPOSES
 With a range that includes light, medium and heavy-duty drawer slides, as well as locking and non-locking products.

SOFT CLOSE DRAWER SLIDES FIT FOR RESIDENTIAL AND COMMERCIAL USE

From residential homes to commercial office buildings, our soft close drawer slides are the perfect option for those who need a quality made product that will be able to fit a variety of uses around their home or workplace.

DRAWER SLIDES

SCHÜTT'S HARDWARE

SKU	MATERIAL	LOCKABLE	LENGTH	CAPACITY
DSCHMD300	Zinc Plated Steel	No	300mm	125kg
DSCHMD350	Zinc Plated Steel	No	350mm	125kg
DSCHMD400	Zinc Plated Steel	No	400mm	125kg
DSCHMD450	Zinc Plated Steel	No	450mm	125kg
DSCHMD500	Zinc Plated Steel	No	500mm	125kg
DSCHMD550	Zinc Plated Steel	No	550mm	110kg
DSCHMD600	Zinc Plated Steel	No	600mm	105kg
DSCHMD650	Zinc Plated Steel	No	650mm	100kg
DSCHLD700	Zinc Plated Steel	No	700mm	95kg
DSCHMD750	Zinc Plated Steel	No	750mm	90kg
DSCHMD900	Zinc Plated Steel	No	900mm	75kg
DSCHMD300-L	Zinc Plated Steel	Yes	300mm	125kg
DSCHMD350-L	Zinc Plated Steel	Yes	350mm	125kg
DSCHMD400-L	Zinc Plated Steel	Yes	400mm	125kg
DSCHMD450-L	Zinc Plated Steel	Yes	450mm	125kg
DSCHMD500-L	Zinc Plated Steel	Yes	500mm	125kg
DSCHMD550-L	Zinc Plated Steel	Yes	550mm	110kg
DSCHMD600-L	Zinc Plated Steel	Yes	600mm	105kg
DSCHMD650-L	Zinc Plated Steel	Yes	650mm	100kg
DSCHLD700-L	Zinc Plated Steel	Yes	700mm	95kg
DSCHMD750-L	Zinc Plated Steel	Yes	750mm	90kg
DSCHMD800-L	Zinc Plated Steel	Yes	800mm	85kg
DSCHMD850-L	Zinc Plated Steel	Yes	850mm	80kg
DSCHMD900-L	Zinc Plated Steel	Yes	900mm	75kg
DSCHMD1000-L	Zinc Plated Steel	Yes	1000mm	70kg

Heavy Duty Drawerslides



SKU	MATERIAL	LOCKABLE	LENGTH	CAPACITY
DSCHHD450	Zinc Plated Steel	No	450mm	225kg
DSCHHD500	Zinc Plated Steel	No	500mm	225kg
DSCHHD550	Zinc Plated Steel	No	550mm	225kg
DSCHHD600	Zinc Plated Steel	No	600mm	225kg
DSCHHD650	Zinc Plated Steel	No	650mm	225kg
DSCHHD700	Zinc Plated Steel	No	700mm	225kg
DSCHHD750	Zinc Plated Steel	No	750mm	225kg
DSCHHD800	Zinc Plated Steel	No	800mm	220kg
DSCHHD850	Zinc Plated Steel	No	850mm	210kg
DSCHHD900	Zinc Plated Steel	No	900mm	205kg
DSCHHD950	Zinc Plated Steel	No	950mm	200kg
DSCHHD1000	Zinc Plated Steel	No	1000mm	195kg
DSCHHD1050	Zinc Plated Steel	No	1050mm	190kg
DSCHHD1100	Zinc Plated Steel	No	1100mm	185kg
DSCHHD1200	Zinc Plated Steel	No	1200mm	175kg
DSCHHD1300	Zinc Plated Steel	No	1300mm	170kg
DSCHHD1350	Zinc Plated Steel	No	1350mm	165kg
DSCHHD1400	Zinc Plated Steel	No	1400mm	160kg
DSCHHD1500	Zinc Plated Steel	No	1500mm	140kg
DSCHHD450-L	Zinc Plated Steel	Yes	450mm	225kg
DSCHHD500-L	Zinc Plated Steel	Yes	500mm	225kg
DSCHHD550-L	Zinc Plated Steel	Yes	550mm	225kg
DSCHHD600-L	Zinc Plated Steel	Yes	600mm	225kg
DSCHHD650-L	Zinc Plated Steel	Yes	650mm	225kg
DSCHHD700-L	Zinc Plated Steel	Yes	700mm	225kg
DSCHHD750-L	Zinc Plated Steel	Yes	750mm	225kg
DSCHHD800-L	Zinc Plated Steel	Yes	800mm	220kg
DSCHHD850-L	Zinc Plated Steel	Yes	850mm	210kg
DSCHHD900-L	Zinc Plated Steel	Yes	900mm	205kg
DSCHHD1000-L	Zinc Plated Steel	Yes	1000mm	195kg
DSCHHD1100-L	Zinc Plated Steel	Yes	1100mm	185kg
DSCHHD1150-L	Zinc Plated Steel	Yes	1150mm	180kg
DSCHHD1300-L	Zinc Plated Steel	Yes	1300mm	170kg
DSCHHD1350-L	Zinc Plated Steel	Yes	1350mm	165kg
DSCHHD1400-L	Zinc Plated Steel	Yes	1400mm	160kg
DSCHHD1500-L	Zinc Plated Steel	Yes	1500mm	140kg

DRAWER SLIDES

SCHUTTS HARDWARE

SCHÜTTTS

HARDWARE



SCHÜTTTS
INDUSTRIAL



SCHUTTS STRUTS

SCHUTTS STRUTS offer an extensive range in all sizes from 6/15, 8/18, 10/22, & 14/28 that suit motor vehicles, caravans, boats, tool boxes plus many other applications. All of our Schutts Gas Struts are backed by a 2-year replacement warranty.

01 6/15 Gas Struts	96
02 8/19 Gas Struts	98
03 10/22 Gas Struts	100
04 14/28 Gas Struts	102
05 Stainless Gas Struts	103

Gas Strut Information

How To Order A Gas Strut

If you are unsure of which gas strut you have, you can still place an order. We just need the following:

1. Overall extended length (centre to centre).
2. Body diameter (thickness of the body of the gas strut).
3. Pressure (usually written on the side of the gas strut eg: 200N).
4. End fittings (Please see the available end fittings below).
5. Understanding your application & the dead weights you are working with is important.

You can use the table below to select the appropriate gas strut and order using the SKU template.

Gas Strut Profiles

PROFILE	ROD SIZE	BODY SIZE	PRESSURE (FORCE)	THREAD / PITCH	SIZE RANGE
6/15	6mm	15mm	50N - 400N	M6 x 1.0	128mm - 500mm
8/18	8mm	19mm	50N - 700N	M6 x 1.0	175mm - 800mm
10/22	10mm	22mm	100N - 1200N	M8 x 1.25	195mm - 1200mm
14/28	14mm	28mm	100N - 2200N	M10 x 1.5	195mm - 1200mm

SKU Code Breakdown

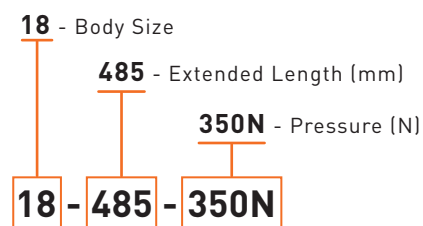

[Note: This is a sample SKU only.]

NOTE: Limited M8 Also Available for 14/28 Gas Struts.

End Fittings To Suit All Gas Struts

Available in a range of various size on enquiry.

Cup Ends



NOTE: 500N Maximum Supported Pressure for Plastic Cups.

Eyelet Ends



Clevis Ends



Mounting Brackets



6/15 Gas Struts

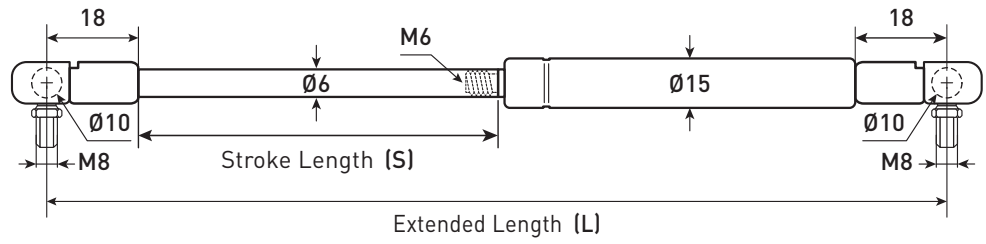

SKU	EXTENDED LENGTH (L)	STROKE LENGTH (S)	COMPRESSED LENGTH	PRESSURE (FORCE)	THREAD / PITCH
15-128	128	30	98	50N - 400N	M6 x 1.0
15-142	142	35	107	50N - 400N	M6 x 1.0
15-150	150	40	110	50N - 400N	M6 x 1.0
15-165	165	45	120	50N - 400N	M6 x 1.0
15-180	180	55	125	50N - 400N	M6 x 1.0
15-195	195	60	135	50N - 400N	M6 x 1.0
15-220	220	75	145	50N - 400N	M6 x 1.0
15-230	230	80	150	50N - 400N	M6 x 1.0
15-240	240	85	155	50N - 400N	M6 x 1.0
15-250	250	85	160	50N - 400N	M6 x 1.0
15-280	280	105	175	50N - 400N	M6 x 1.0
15-315	315	120	195	50N - 400N	M6 x 1.0
15-330	330	130	200	50N - 400N	M6 x 1.0
15-340	340	135	205	50N - 400N	M6 x 1.0
15-355	355	140	215	50N - 400N	M6 x 1.0
15-375	375	150	225	50N - 400N	M6 x 1.0
15-380	380	155	225	50N - 400N	M6 x 1.0
15-410	410	170	240	50N - 400N	M6 x 1.0
15-430	430	180	250	50N - 400N	M6 x 1.0
15-500	500	215	285	50N - 400N	M6 x 1.0
15-505	505	210	285	50N - 400N	M6 x 1.0

6/15 GAS STRUTS

SCHUTTS STRUTS

8/19 Gas Struts

8/19 GAS STRUTS

SCHUTTS STRUTS



Medium-Duty Gas Struts:

- Ideal for medium-sized use.
- Suitable for various applications including automotive, marine, and industrial machinery.
- 8/19mm rod and tube diameter combination provides smooth and consistent operation.
- Available in a range of lengths and pressures to suit various applications.

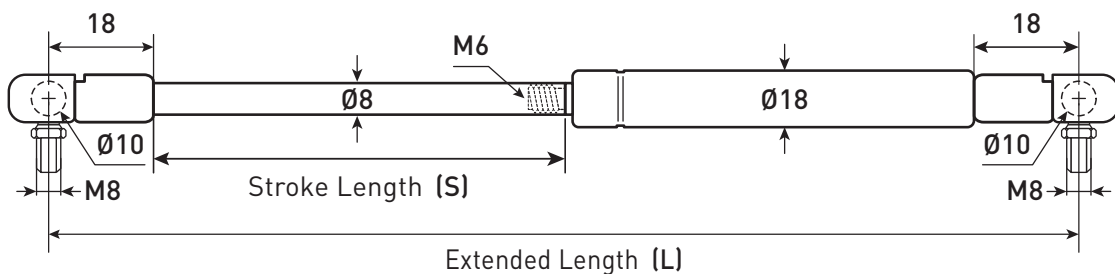

SKU	EXTENDED LENGTH (L)	STROKE LENGTH (S)	COMPRESSED LENGTH	PRESSURE (FORCE)	THREAD / PITCH
18-165	165	45	120	50N - 700N	M6 x 1.0
18-175	175	50	125	50N - 700N	M6 x 1.0
18-195	195	60	135	50N - 700N	M6 x 1.0
18-220	220	70	150	50N - 700N	M6 x 1.0
18-230	230	75	155	50N - 700N	M6 x 1.0
18-245	245	85	160	50N - 700N	M6 x 1.0
18-250	250	85	160	50N - 700N	M6 x 1.0
18-265	265	95	170	50N - 700N	M6 x 1.0
18-275	275	100	175	50N - 700N	M6 x 1.0
18-290	290	105	180	50N - 700N	M6 x 1.0
18-305	305	115	190	50N - 700N	M6 x 1.0
18-315	315	115	195	50N - 700N	M6 x 1.0
18-320	320	120	200	50N - 700N	M6 x 1.0
18-330	330	125	205	50N - 700N	M6 x 1.0
18-336	336	130	206	50N - 700N	M6 x 1.0
18-340	340	130	205	50N - 700N	M6 x 1.0
18-350	350	135	215	50N - 700N	M6 x 1.0
18-365	365	145	220	50N - 700N	M6 x 1.0
18-375	375	150	225	50N - 700N	M6 x 1.0
18-385	385	155	230	50N - 700N	M6 x 1.0
18-405	405	165	240	50N - 700N	M6 x 1.0
18-410	410	165	245	50N - 700N	M6 x 1.0
18-415	415	170	245	50N - 700N	M6 x 1.0
18-430	430	175	250	50N - 700N	M6 x 1.0
18-450	450	185	265	50N - 700N	M6 x 1.0
18-460	460	190	270	50N - 700N	M6 x 1.0
18-465	465	195	270	50N - 700N	M6 x 1.0

SKU	EXTENDED LENGTH (L)	STROKE LENGTH (S)	COMPRESSED LENGTH	PRESSURE (FORCE)	THREAD / PITCH
18-470	470	195	275	50N - 700N	M6 x 1.0
18-485	485	205	280	50N - 700N	M6 x 1.0
18-500	500	210	290	50N - 700N	M6 x 1.0
18-505	505	215	290	50N - 700N	M6 x 1.0
18-510	510	215	295	50N - 700N	M6 x 1.0
18-520	520	215	295	50N - 700N	M6 x 1.0
18-525	525	225	300	50N - 700N	M6 x 1.0
18-535	535	230	305	50N - 700N	M6 x 1.0
18-540	540	235	305	50N - 700N	M6 x 1.0
18-550	550	235	310	50N - 700N	M6 x 1.0
18-565	565	235	320	50N - 700N	M6 x 1.0
18-575	575	250	325	50N - 700N	M6 x 1.0
18-585	585	255	330	50N - 700N	M6 x 1.0
18-595	595	260	335	50N - 700N	M6 x 1.0
18-600	600	265	335	50N - 700N	M6 x 1.0
18-615	615	270	345	50N - 700N	M6 x 1.0
18-630	630	275	355	50N - 700N	M6 x 1.0
18-650	650	285	365	50N - 700N	M6 x 1.0
18-670	670	295	375	50N - 700N	M6 x 1.0
18-680	680	305	385	50N - 700N	M6 x 1.0
18-700	700	315	385	50N - 700N	M6 x 1.0
18-720	720	320	395	50N - 700N	M6 x 1.0
18-730	730	330	400	50N - 700N	M6 x 1.0
18-750	750	335	410	50N - 700N	M6 x 1.0
18-775	775	350	425	50N - 700N	M6 x 1.0
18-800	800	360	435	50N - 700N	M6 x 1.0

10/22 Gas Struts



Semi-Heavy-Duty Gas Struts:

- Offer a semi-heavy-duty option suitable for various industrial and automotive applications.
- Designed to withstand complex environments and provide smooth and controlled motion, making them an ideal choice for applications that require precision and strength.
- Available in a range of lengths and pressures to suit various applications.

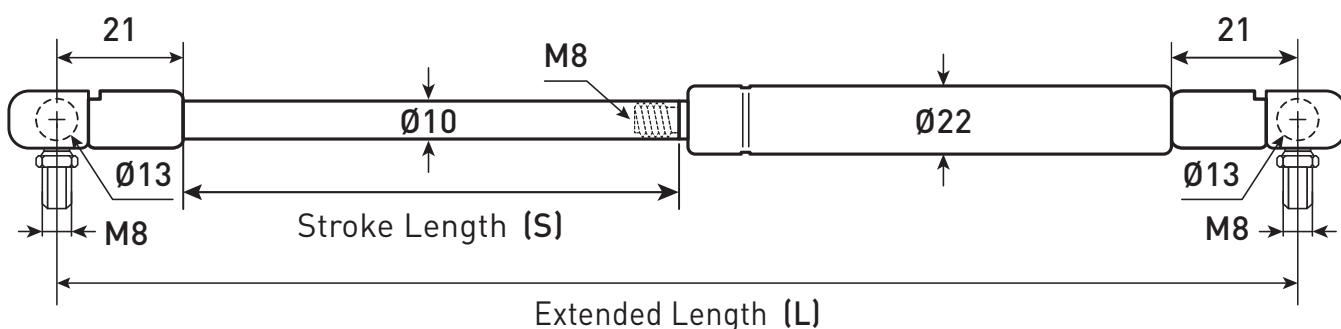

SKU	EXTENDED LENGTH (L)	STROKE LENGTH (S)	PRESSURE (FORCE)	THREAD / PITCH
22-195	195	60	50N - 1200N	M8 x 1.25
22-250	250	85	50N - 1200N	M8 x 1.25
22-295	295	105	50N - 1200N	M8 x 1.25
22-330	330	125	50N - 1200N	M8 x 1.25
22-350	350	135	50N - 1200N	M8 x 1.25
22-375	375	145	50N - 1200N	M8 x 1.25
22-395	395	160	50N - 1200N	M8 x 1.25
22-405	405	160	50N - 1200N	M8 x 1.25
22-430	430	170	50N - 1200N	M8 x 1.25
22-450	450	180	50N - 1200N	M8 x 1.25
22-485	485	205	50N - 1200N	M8 x 1.25
22-500	500	210	50N - 1200N	M8 x 1.25
22-505	505	215	50N - 1200N	M8 x 1.25
22-525	525	225	50N - 1200N	M8 x 1.25

SKU	EXTENDED LENGTH (L)	STROKE LENGTH (S)	PRESSURE (FORCE)	THREAD / PITCH
22-550	550	235	50N - 1200N	M8 x 1.25
22-560	560	240	50N - 1200N	M8 x 1.25
22-565	565	240	50N - 1200N	M8 x 1.25
22-575	575	245	50N - 1200N	M8 x 1.25
22-595	595	255	50N - 1200N	M8 x 1.25
22-620	620	270	50N - 1200N	M8 x 1.25
22-630	630	275	50N - 1200N	M8 x 1.25
22-650	650	285	50N - 1200N	M8 x 1.25
22-670	670	290	50N - 1200N	M8 x 1.25
22-700	700	310	50N - 1200N	M8 x 1.25
22-730	730	325	50N - 1200N	M8 x 1.25
22-750	750	335	50N - 1200N	M8 x 1.25
22-770	770	340	50N - 1200N	M8 x 1.25
22-795	795	360	50N - 1200N	M8 x 1.25
22-816	816	365	50N - 1200N	M8 x 1.25
22-830	830	375	50N - 1200N	M8 x 1.25
22-850	850	385	50N - 1200N	M8 x 1.25
22-900	900	410	50N - 1200N	M8 x 1.25
22-930	930	425	50N - 1200N	M8 x 1.25
22-940	940	430	50N - 1200N	M8 x 1.25
22-975	975	450	50N - 1200N	M8 x 1.25
22-1035	1035	475	50N - 1200N	M8 x 1.25
22-1100	1100	500	50N - 1200N	M8 x 1.25
22-1200	1200	560	50N - 1200N	M8 x 1.25

10/22 GAS STRUTS

SCHUTTS STRUTS

14/28 Gas Struts

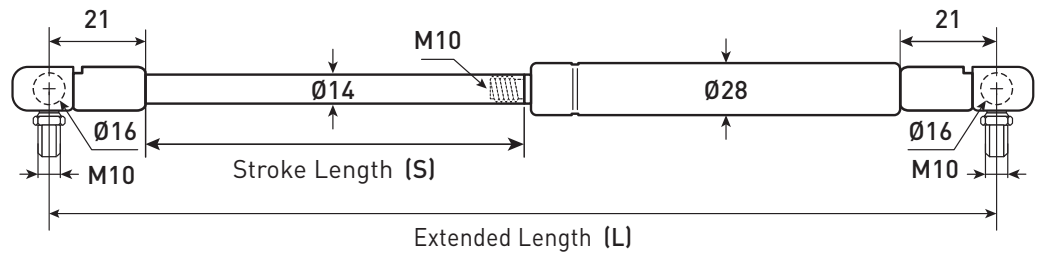

14/28 GAS STRUTS

SCHÜTT'S STRUTS

SKU	EXTENDED LENGTH (L)	STROKE LENGTH (S)	PRESSURE (FORCE)	THREAD / PITCH
28-195	195	95	100N - 2200N	M10 X 1.5
28-250	250	95	100N - 2200N	M10 X 1.5
28-295	295	95	100N - 2200N	M10 X 1.5
28-330	330	115	100N - 2200N	M10 X 1.5
28-375	375	135	100N - 2200N	M10 X 1.5
28-405	405	125	100N - 2200N	M10 X 1.5
28-430	430	165	100N - 2200N	M10 X 1.5
28-450	450	165	100N - 2200N	M10 X 1.5
28-485	485	190	100N - 2200N	M10 X 1.5
28-505	505	200	100N - 2200N	M10 X 1.5
28-525	525	205	100N - 2200N	M10 X 1.5
28-550	550	220	100N - 2200N	M10 X 1.5
28-600	600	250	100N - 2200N	M10 X 1.5
28-630	630	260	100N - 2200N	M10 X 1.5
28-640	640	270	100N - 2200N	M10 X 1.5
28-650	650	275	100N - 2200N	M10 X 1.5
28-670	670	275	100N - 2200N	M10 X 1.5
28-700	700	295	100N - 2200N	M10 X 1.5
28-720	720	305	100N - 2200N	M10 X 1.5
28-730	730	310	100N - 2200N	M10 X 1.5
28-750	750	320	100N - 2200N	M10 X 1.5
28-800	800	345	100N - 2200N	M10 X 1.5
28-830	830	365	100N - 2200N	M10 X 1.5
28-850	850	380	100N - 2200N	M10 X 1.5
28-885	885	385	100N - 2200N	M10 X 1.5
28-900	900	400	100N - 2200N	M10 X 1.5
28-940	940	400	100N - 2200N	M10 X 1.5
28-1100	1100	500	100N - 2200N	M10 X 1.5
28-1200	1200	550	100N - 2200N	M10 X 1.5

**STAINLESS STEEL
6/15 Gas Struts**

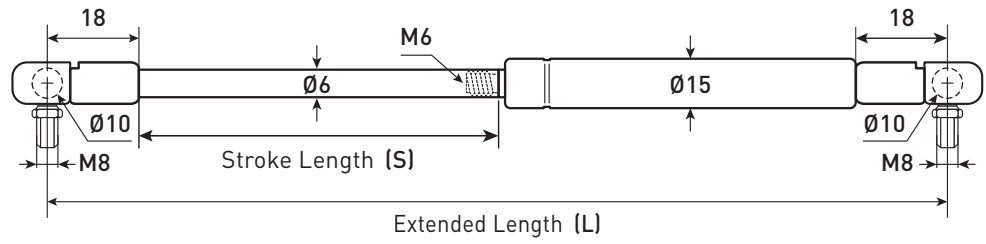

SKU	EXTENDED LENGTH (L)	STROKE LENGTH (S)	COMPRESSED LENGTH	PRESSURE (FORCE)	THREAD / PITCH
15-155SS	155	45	110	50N - 400N	M6 x 1.0
15-195SS	195	60	135	50N - 400N	M6 x 1.0
15-235SS	235	80	155	50N - 400N	M6 x 1.0
15-255SS	255	90	165	50N - 400N	M6 x 1.0
15-275SS	275	100	175	50N - 400N	M6 x 1.0
15-315SS	315	120	195	50N - 400N	M6 x 1.0
15-375SS	375	150	225	50N - 400N	M6 x 1.0
15-390SS	390	155	235	50N - 400N	M6 x 1.0

8/19 Gas Struts



Medium-Duty Gas Struts:

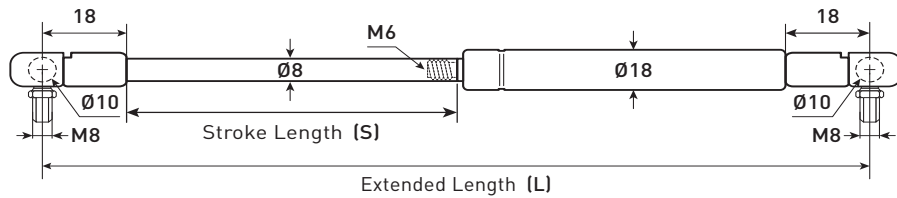

SKU	EXTENDED LENGTH (L)	STROKE LENGTH (S)	COMPRESSED LENGTH	PRESSURE (FORCE)	THREAD / PITCH
18-310SS	310	115	195	50N - 700N	M6 x 1.0
18-350SS	350	135	210	50N - 700N	M6 x 1.0
18-390SS	390	155	230	50N - 700N	M6 x 1.0
18-400SS	400	165	245	50N - 700N	M6 x 1.0
18-410SS	410	165	245	50N - 700N	M6 x 1.0
18-510SS	510	215	295	50N - 700N	M6 x 1.0
18-525SS	525	225	300	50N - 700N	M6 x 1.0
18-565SS	565	240	300	50N - 700N	M6 x 1.0
18-585SS	585	255	330	50N - 700N	M6 x 1.0
18-600SS	600	260	330	50N - 700N	M6 x 1.0
18-610SS	610	265	340	50N - 700N	M6 x 1.0
18-630SS	630	275	340	50N - 700N	M6 x 1.0
18-650SS	650	285	350	50N - 700N	M6 x 1.0
18-710SS	710	315	390	50N - 700N	M6 x 1.0

STAINLESS GAS STRUTS

SCHUTTS STRUTS

10/22 Gas Struts

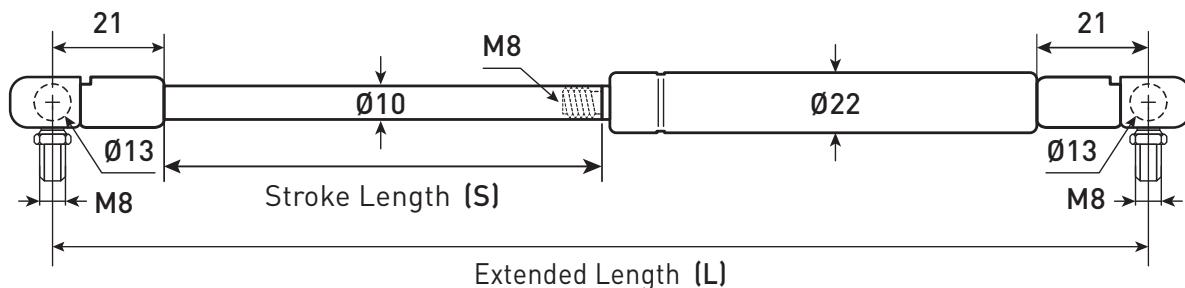

Semi-Heavy-Duty Gas Struts:

- Offers a semi-heavy-duty option suitable for various industrial and automotive applications.
- Designed to withstand complex environments and provide smooth and controlled motion, making them an ideal choice for applications that require precision and strength.
- Available in a range of lengths and pressures to suit various applications.

SKU	EXTENDED LENGTH (L)	STROKE LENGTH (S)	PRESSURE (FORCE)	THREAD / PITCH
22-295SS	295	100	50N- 1200N	M8 x 1.25
22-350SS	350	135	50N- 1200N	M8 x 1.25
22-405SS	405	155	50N- 1200N	M8 x 1.25
22-450SS	450	185	50N- 1200N	M8 x 1.25
22-505SS	505	205	50N- 1200N	M8 x 1.25
22-525SS	525	220	50N- 1200N	M8 x 1.25
22-710SS	710	310	50N - 1200N	M8 x 1.25
22-820SS	820	380	50N - 1200N	M8 x 1.25

14/28 Gas Struts

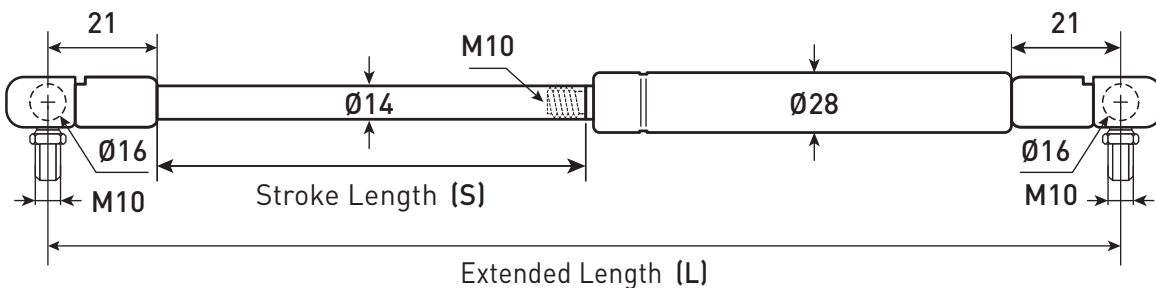

SKU	EXTENDED LENGTH (L)	STROKE LENGTH (S)	PRESSURE (FORCE)	THREAD / PITCH
28-505SS	505	205	100N - 2000N	M10 X 1.5
28-710SS	710	290	100N - 2000N	M10 X 1.5
28-820SS	820	365	100N - 2000N	M10 X 1.5
28-910SS	910	400	100N - 2000N	M10 X 1.5
28-1100SS	1100	500	100N - 2000N	M10 X 1.5

SCHÜTTTS STRUTS

★	★	★	★
Cabinets / Furniture	Tool / Ute Boxes	Cars / Caravans	Boats / Marine
Light-Duty	Medium-Duty	Heavy-Duty	Stainless
6/15	8/18	10/22 & 14/28	Steel



2 YEARS WARRANTY

SCHÜTTTS

More Than Opens And Schütts

ALL YOUR RETAIL FITOUT NEEDS

MAKING YOU LOOK GOOD!

We offer a fully fitted out POS and in-store display solution to help you capitalise on your Schutts Industrial product sales.

CRANE
"Lift with Confidence"

GRANGE
"Move with Confidence"

SCHÜTT'S CARGO

SCHÜTT'S
HARDWARE

SCHÜTT'S STRUTS



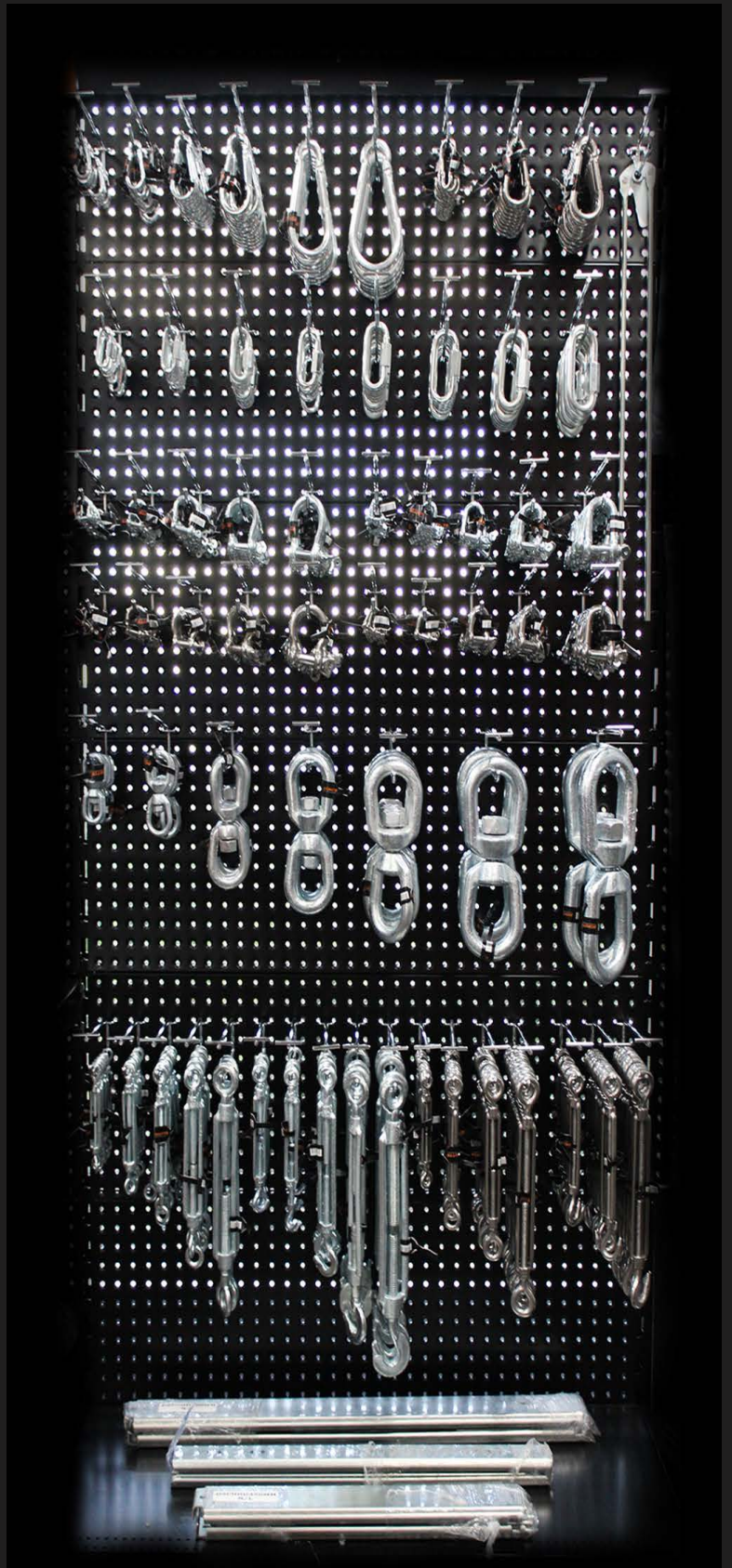

SCHÜTT'S CARGO

SCHÜTT'S

SCHÜTT'S

More Than Opens And Schutts





SCHÜTTTS

INDUSTRIAL

DATE OF PURCHASE:

SERIAL NO.:

DATE OF INDUCTION INTO SERVICE:

DESCRIPTION:

DATE OF INSPECTION		/ /		/ /		/ /		/ /		/ /	
CHECKLIST		YES	NO	YES	NO	YES	NO	YES	NO	YES	NO
External Wear/ Local Abrasion	Is the sling generally worn (furry appearance) or showing any local abrasion?	<input type="checkbox"/>	<input type="checkbox"/>	<input type="checkbox"/>	<input type="checkbox"/>	<input type="checkbox"/>	<input type="checkbox"/>	<input type="checkbox"/>	<input type="checkbox"/>	<input type="checkbox"/>	<input type="checkbox"/>
Cuts and Contusions	Are there cuts of any kind in the fibres?	<input type="checkbox"/>	<input type="checkbox"/>	<input type="checkbox"/>	<input type="checkbox"/>	<input type="checkbox"/>	<input type="checkbox"/>	<input type="checkbox"/>	<input type="checkbox"/>	<input type="checkbox"/>	<input type="checkbox"/>
Damage to Protective Coating or Sleeve	Has dirt been allowed to enter the fibres of the sling?	<input type="checkbox"/>	<input type="checkbox"/>	<input type="checkbox"/>	<input type="checkbox"/>	<input type="checkbox"/>	<input type="checkbox"/>	<input type="checkbox"/>	<input type="checkbox"/>	<input type="checkbox"/>	<input type="checkbox"/>
Damage from high temperature	Is there any indication that the sling has been compromised by excessive heat?	<input type="checkbox"/>	<input type="checkbox"/>	<input type="checkbox"/>	<input type="checkbox"/>	<input type="checkbox"/>	<input type="checkbox"/>	<input type="checkbox"/>	<input type="checkbox"/>	<input type="checkbox"/>	<input type="checkbox"/>
Chemical Attack	Has any chemical exposure weakened, softened or made the fibres flakes?	<input type="checkbox"/>	<input type="checkbox"/>	<input type="checkbox"/>	<input type="checkbox"/>	<input type="checkbox"/>	<input type="checkbox"/>	<input type="checkbox"/>	<input type="checkbox"/>	<input type="checkbox"/>	<input type="checkbox"/>
Label Damage	Is the label missing, damaged or illegible?	<input type="checkbox"/>	<input type="checkbox"/>	<input type="checkbox"/>	<input type="checkbox"/>	<input type="checkbox"/>	<input type="checkbox"/>	<input type="checkbox"/>	<input type="checkbox"/>	<input type="checkbox"/>	<input type="checkbox"/>
Deterioration of Stitching	Is the stitching unsound?	<input type="checkbox"/>	<input type="checkbox"/>	<input type="checkbox"/>	<input type="checkbox"/>	<input type="checkbox"/>	<input type="checkbox"/>	<input type="checkbox"/>	<input type="checkbox"/>	<input type="checkbox"/>	<input type="checkbox"/>
Any Damage	Any damage to the eyes or connecting fittings?	<input type="checkbox"/>	<input type="checkbox"/>	<input type="checkbox"/>	<input type="checkbox"/>	<input type="checkbox"/>	<input type="checkbox"/>	<input type="checkbox"/>	<input type="checkbox"/>	<input type="checkbox"/>	<input type="checkbox"/>
INSPECTORS SIGNATURE:											

IF YOU HAVE ANSWERED YES TO ANY OF THE QUESTIONS ABOVE, REMOVE THE SLING FROM SERVICE.

INSPECTION PROCEDURES

- Slings should be inspected by a competent person a minimum of every 3 months. (More often in severe conditions.)
- If there are any signs of damage, remove the sling from service.
- Details of each periodic inspection must be kept for the life of the sling.

BEFORE EACH USE

- Inspect slings before every use for any sign of damage.
- Ensure the tag is present and undamaged.

Visit our website www.schutts.com.au for further information and downloads.

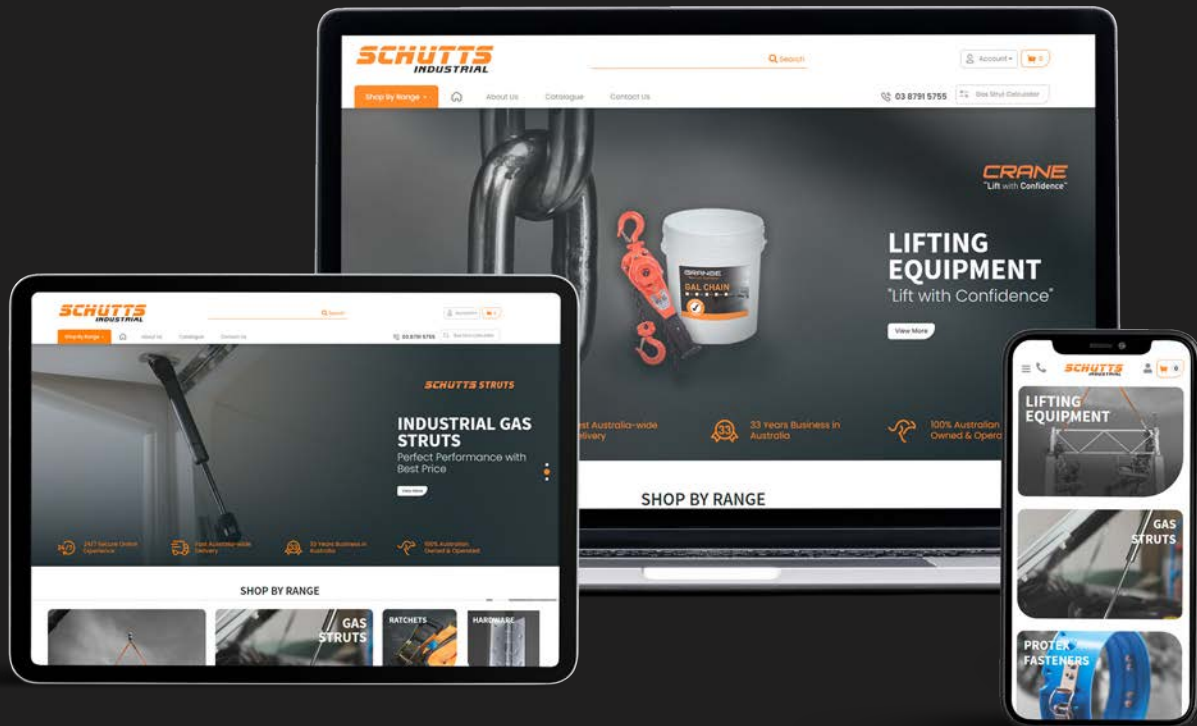

Download our digital catalogue

 sales@schutts.com.au

 www.schutts.com.au



© SCHUTTS INDUSTRIAL PTY. LTD. ABN 64 663 036 904

No part of this catalogue may be reproduced, stored in a system or transmitted in any form by means, including electronic, mechanical, photocopying, recording or otherwise, without prior permission of Schutts Industrial Pty. Ltd. All items in this catalogue have been included in good faith on the basis that the goods, as described, will be available for sale. A failure by the supplier to deliver in accordance with sample, description or at all or other unintentional causes may result in some items being unavailable.

Display accessories shown in photographs throughout this publication are not included in the price. Whilst every care has been taken to ensure accuracy in this catalogue, due to technical effects, there could be some slight difference in the colour tone of pictures and the actual item. All graphics are used for illustration purpose only. Specifications and descriptions are correct with our current stock holdings. What we receive can vary between 0.5 percent - 5 percent approx difference in measurements.

We reserve the right to change products resulting from printing or typographical error. Printed for Schutts Industrial Pty. Ltd.

SCHÜTTTS[®] **INDUSTRIAL**

MORE THAN OPENS AND SCHUTTS



ADDRESS

285-289 Abbots Road,
Dandenong South VIC 3175

EMAIL

Sales@schutts.com.au

PHONE

03 0791 5755

YOUR SPECIALIST DISTRIBUTOR:

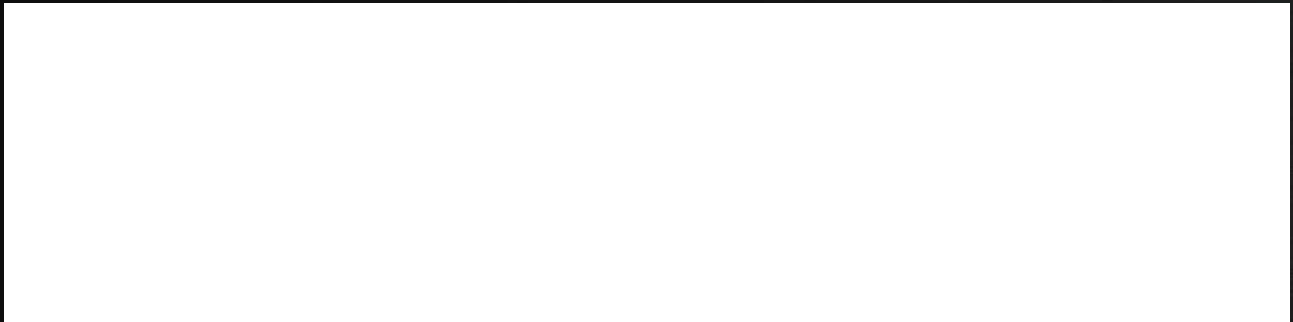

CRANE[™]
"Lift with Confidence"

GRANGE[™]
"Move with Confidence"

PROTEX[®]

SCHÜTTTS[™]
HARDWARE

SCHÜTTTS CARGO[™]

SCHÜTTTS STRUTS[™]

WWW.SCHUTTS.COM.AU